



# PUMP PRODUCT PORTFOLIO



*Experience In Motion*



# TABLE OF CONTENTS

**Experience In Motion** . . . . . 4  
**Solving the World’s Toughest Pumping Challenges** . . . . . 6  
**Industries** . . . . . 8  
**Applications** . . . . . 10  
**Services** . . . . . 12  
**Mechanical Seals and Systems** . . . . . 14  
**Other Flowserve Products** . . . . . 16  
**When and Where You Need Us** . . . . . 17

## **Overhung Pumps**

Quick Reference Chart . . . . . 21  
Chemical Process — ASME, ISO . . . . . 24  
Industrial Process . . . . . 26  
Solids Handling . . . . . 30  
Slurry . . . . . 32  
API Process . . . . . 33  
Axial Flow . . . . . 36

## **Between Bearings Pumps**

Quick Reference Chart . . . . . 39  
Single-Case — Axially Split . . . . . 42  
Single-Case — Axially Split — API . . . . . 42  
Single-Case — Axially Split — Multistage . . . . . 44  
Single-Case — Radially Split . . . . . 44  
Horizontal — Multistage — Single-Case . . . . . 46  
Horizontal — Multistage — Double-Case . . . . . 49

## **Vertical Pumps**

Quick Reference Chart . . . . . 53  
Wet-Pit . . . . . 55  
Double-Case . . . . . 57  
Deep-Well . . . . . 59  
Slurry . . . . . 60  
Solids Handling . . . . . 61  
Sump . . . . . 62

## **Positive Displacement Pumps**

Quick Reference Chart . . . . . 65  
Diaphragm . . . . . 66  
Gear . . . . . 66  
Twin Screw . . . . . 67  
Multiphase Twin Screw . . . . . 67

**Side Channel**

Quick Reference Chart . . . . . 69  
Side Channel . . . . . 71

**Vacuum Pumps & Compressors**

Quick Reference Chart . . . . . 77  
Dry Vacuum Pumps . . . . . 79  
Liquid Ring Vacuum Pumps . . . . . 79  
Liquid Ring Compressors . . . . . 80  
Vacuum, Membrane and  
Compressor Systems . . . . . 81

**Specialty Products**

Quick Reference Chart . . . . . 83  
Nuclear Pumps and Seals . . . . . 85  
Hydraulic Decoking Systems . . . . . 89  
Energy Recovery Devices . . . . . 90  
Concrete Volute . . . . . 90  
Polyolefin Reactor . . . . . 91

**Reference Sources** . . . . . 92

**Index** . . . . . 93





## EXPERIENCE IN MOTION

Every day, our customers are challenged to take their plant operations to the next level. To do that, they need partners who deliver much more than products.

Flowserve is answering that call. We're working with the world's most important providers of oil and gas, power, chemicals, water and other essential products to solve the absolute toughest challenges in fluid motion and control.

Our industry-leading portfolio of pumps, seals, valves and actuation is only part of the story. Our customers need answers that demand extensive know-how and experience, and we've got it. More than 18 000 committed associates are go-to resources for expert engineering, project management, technical support and service in every corner of the world.



### Expertise and Experience

Flowserve has an unrivaled combination of technical expertise and practical experience to help you solve the toughest fluid motion control challenges.

### Proven Quality and Reliability

Flowserve products are designed for maximum safety and reliability — all to help you reduce unplanned downtime while keeping workers and plant assets safe.

### Comprehensive Portfolio

Flowserve offers the world's most complete portfolio of pumps, seals, valves and actuation. As a result, you'll get the best solution with minimal time shopping and evaluating.

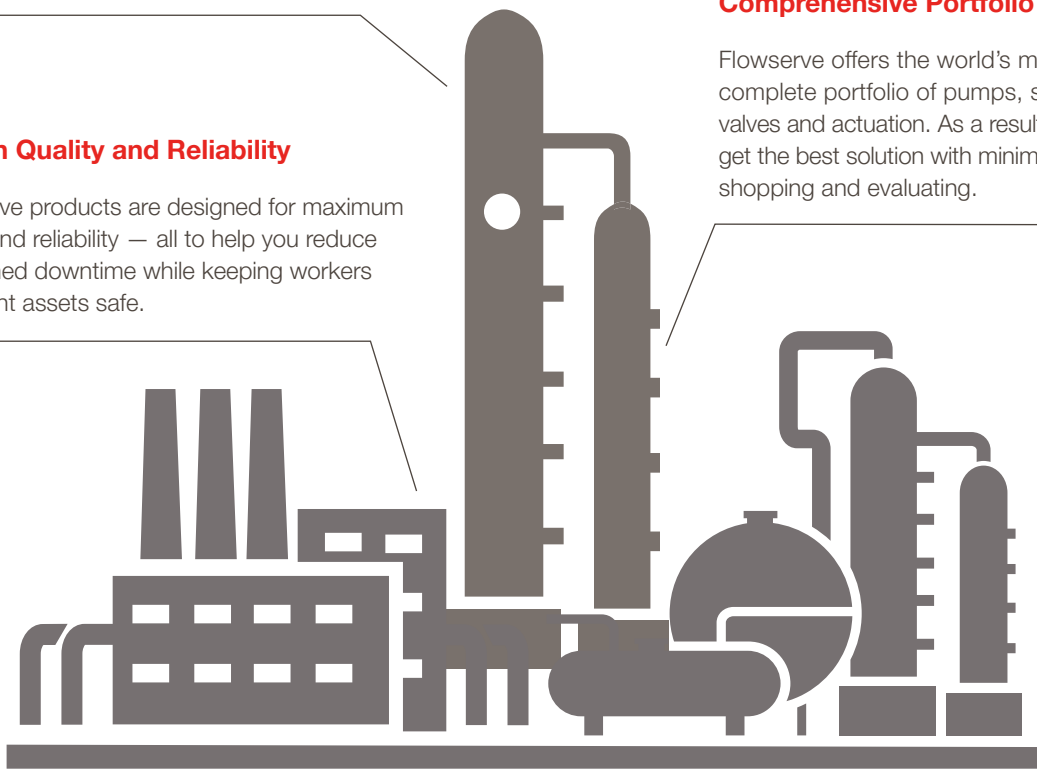

### Technology and Insights

We help maximize your systems' efficiency and uptime by applying flow-specific technologies and advanced aftermarket capabilities, all supported by a vast team of technical resources.

### Local Support Worldwide

Flowserve is everywhere you do business. Our global network of Quick Response Centers helps to minimize downtime with hands-on support that's fast and dependable.



## SOLVING THE WORLD'S TOUGHEST PUMPING CHALLENGES

The most aggressive fluids and slurries on the planet. High-volume and high-pressure applications that test the limits of hydraulic and mechanical design. That's where you'll find Flowserve pumps performing efficiently, safely and reliably. It's a legacy that goes back centuries — one we build upon every day, outperforming expectations no matter how great the demands.

Flowserve is the driving force in the global pump marketplace. No other pump company in the world has the depth or breadth of expertise in the successful application of preengineered, engineered, and special purpose pumps and systems.

Global customers can easily find configurations to precisely match the pumping requirements that drive their operations, even specialty applications most pump companies have never heard of. From small pumps that dependably process thousands of end products day-in and day-out, to massive machines that efficiently move the fluids that are the lifeblood of our industrial infrastructure, Flowserve carefully engineers the highest degrees of reliability and performance into every product. It's a commitment that ensures maximum uptime from every pump we deliver.

## WORLD-RENOWNED BRANDS

Flowserve can trace its expertise in the pumps industry back to the 18th century and the earliest application of steampumping engines. Today, the Flowserve pump portfolio boasts some of the world's most renowned pump brands.



Aldrich™

Byron Jackson®

Calder® Energy Recovery Devices

Durco®

Flowserve®

HALBERG®

IDP™

INNOMAG®

Lawrence Pumps®

Niigata Worthington™

Pacific®

Scienco®

Sier-Bath®

SIHI®

TKL™

Worthington®



## INDUSTRIES

The world's infrastructure industries rely on Flowserve to solve their most complex fluid motion and control challenges. We deliver more than the most complete portfolio of pumps, seals and valves; we help our customers exceed their operational goals. We understand that profitable performance requires critical process equipment and systems operate safely, reliably and at maximum efficiency. Our commitment to meeting these expectations for our customers drives everything we do.



### OIL AND GAS

From production wells deep on ocean floors and remote oil sands, to transportation infrastructures that span continents and refineries that create the world's feedstocks — global energy companies push the limits of fluid motion and control. They need solutions for increasingly demanding applications. To meet their high-temperature, high-pressure processing needs, Flowserve provides unmatched mechanical, hydraulic and materials know-how and the industry's most complete flow management portfolio. Backed by service and support teams around the globe, we can help maximize uptime, productivity and safety, and keep you at the forefront of innovation.



### CHEMICAL

Aggressive corrosion and erosion. Hazardous, toxic substances. Application variation that makes equipment specification more than a little challenging. The chemical industry faces tough challenges, and Flowserve is in the middle of them, solving our customers' most difficult hurdles every day. Our solutions span the industry, from basic, organic, specialty and fine chemicals to biofuels and pharmaceuticals. We continue to build on our materials science heritage and advance sealing and flow control technologies. We do this to help customers improve performance, maximize service life and keep personnel safe.





## **POWER**

Rapid load variations, frequent stops and starts, and the highest temperatures, flows and pressures. Welcome to fluid motion and control in the power industry. These grueling applications are where Flowserve became a driving force in power generation. To appreciate our role, you needn't look further than our pioneering work in nuclear power or the massive machines we've built for conventional steam plants. But that's history. Today, we're developing next generation solutions to meet the newest challenges, including concentrated solar, biomass and geothermal.



## **WATER RESOURCES**

Whether for flood control, desalination, distribution, waste management or agriculture, those who move water need to do it economically, sustainably and reliably. They need low-maintenance equipment and high-efficiency systems that minimize energy consumption. They also need partners who ensure the right solution is specified every time to minimize environmental impacts and control total life cycle costs. Supplying flow management systems for the global water resources is a commitment with far-reaching implications. That's why the world's leading municipalities and water system providers trust Flowserve.



## **GENERAL INDUSTRY**

From paper and metals to sweeteners and electronics, most of the world's products depend on reliable fluid motion and control solutions. Endless demanding and complicated application parameters are found in industries such as food and beverage, mining, steelmaking, and pulp and paper. Flowserve has a global portfolio of solutions and technical expertise capable of tackling the tough and often unique requirements found in these industries. A global network of Quick Response Centers delivers the timely technical support, parts and service needed to keep operations running dependably and profitably.

# APPLICATIONS

		Oil and Gas												Chemical Processing								Power Generation (Fossil, Renewables, Nuclear)												
		Upstream			Mid		Downstream																											
PUMP CATEGORY	Sub-category	Heavy Oil, Oil Sands and Shale	Drilling and Production	Water and CO <sub>2</sub> Injection	Water Supply and Treatment	FPSO	Crude, Product and CO <sub>2</sub> Pipeline	Distillation	Hydrotreating	Hydrocracking	Catalytic Cracking	Residuum and Heavy Oil Upgrading	Gas Treating and Sulfur Recovery	LNG	NGL and LPG	Gas to Liquids	Off-sites and Waste Treatment	Acid Transfer	Caustic and Chlor-alkali	Pharmaceuticals	Polymers	Renewable Fuel Production	Slurry Processing	Solvents	Volatile Organic Compounds	Waste Processing	Auxiliary	Boiler Feed	Boiler Feed Booster	Condensate Extraction	Cooling Water	Flue Gas Desulfurization		
OVERHUNG	Chemical Process—ANSI, ISO	X	X	X	X	X							X	X	X		X	X	X	X	X	X	X	X	X	X								
	Industrial Process	X	X		X	X											X			X			X		X			X	X		X			
	Slurry and Solids Handling	X									X	X	X				X	X	X	X	X	X				X	X						X	
	API Process	X	X	X	X	X		X	X	X	X	X	X	X	X	X		X	X				X	X	X	X	X	X	X	X				
BETWEEN BEARINGS	Single Case — Axially Split	X	X	X	X	X	X						X	X	X	X	X			X		X					X							
	Single Case — Radially Split	X		X		X	X	X	X	X	X	X	X	X	X	X						X					X	X	X				X	
	Horizontal — Multistage Single Case				X																		X				X	X	X	X				
	Horizontal — Multistage Double Case	X		X		X	X		X	X	X	X		X	X	X											X	X						
VERTICAL	Wet-pit		X		X	X								X	X		X					X				X				X	X			
	Double Case			X			X						X	X	X		X	X										X		X				
	Deep Well Submersible Motor		X		X	X																X				X					X			
	Slurry and Solids Handling																X	X	X	X	X		X			X	X						X	
	Sump	X	X		X	X		X	X	X	X	X	X	X	X	X	X	X			X	X	X			X	X							
POSITIVE DISPLACEMENT	Diaphragm																																	
	Gear	X																X	X	X	X		X		X	X								
	Screw	X	X			X	X					X					X			X	X				X	X	X							
	Multiphase	X	X																															
SIDE CHANNEL	Side Channel													X	X		X	X	X	X	X		X			X	X					X		
VACUUM PUMPS & COMPRESSORS	Dry Vacuum Pumps						X													X			X			X								
	Liquid Ring Vacuum Pumps			X			X					X							X	X	X	X		X	X	X							X	
	Liquid Ring Compressors			X								X			X				X	X	X	X		X	X	X							X	
	Systems			X			X					X			X				X	X	X	X		X	X	X							X	
SPECIALTY PRODUCTS	Nuclear Pumps and Seals																																	
	Hydraulic Decoking Systems											X																						
	Energy Recovery Devices																																	
	CVP Concrete Volute Pumps																																X	
	High-temperature Process Slurry	X									X	X				X	X																	
	Axial Flow																					X												
	Polyolefin Reactor																					X												

Power Generation (Fossil, Renewables, Nuclear)						Water Resources										General Industry																											
																Primary Metals					Mining				Pulp and Paper						Other												
Geothermal Well Services	Heat Transfer Fluids	Molten Salt Transfer	Transformer Cooling	Auxiliary Services	Nuclear Service	Desalination	Flood Control	Groundwater Development	Sewage Collection and Treatment	Water Supply and Distribution	Water Treatment	Cooling Water	Descaling	Hydraulic Press	Plating, Galvanizing and Coatings	Scale Recycle	Dewatering and Water Supply	Leaching Acid	Primary Processing	Slurry Transfer	Bleach Chemical	Boiler Feed	Chemical and Liquor	Coatings	Digester	Paper Stock	Shower Pumps	Automotive	Agriculture	Construction	Industrial Gases	Electronics	Fire Protection	Food Processing	HVAC	OEM	Shipping	Snowmaking					
X			X	X	X				X	X	X	X		X	X		X	X			X	X	X	X				X	X	X		X	X	X	X	X	X	X					
	X			X		X		X		X	X	X	X	X	X														X	X	X		X	X	X	X	X	X	X	X			
				X					X	X	X					X	X	X	X	X	X	X	X	X	X	X	X		X	X	X		X		X								
X			X	X	X									X	X		X						X	X					X	X		X											
				X	X		X	X		X	X	X	X				X		X								X	X	X	X	X	X	X	X	X	X	X	X	X	X			
X				X	X					X	X	X	X				X						X							X	X	X		X		X	X	X	X		X		
				X	X							X				X		X				X																					
X	X	X	X	X	X	X	X	X	X	X	X	X			X	X	X	X											X	X	X		X	X	X	X	X	X	X	X	X		
				X	X	X	X		X	X																			X	X	X	X	X	X	X	X	X	X	X	X	X		
			X	X											X								X	X	X					X	X	X		X		X	X	X	X				
				X																X									X	X													
X	X									X												X					X				X							X					
															X																X	X		X	X	X	X	X	X	X			
			X	X	X					X					X							X								X	X		X	X		X	X	X	X	X	X		
			X		X					X				X								X								X	X		X	X		X	X	X	X	X	X	X	
			X	X																																							
				X		X			X	X																																	
				X			X	X		X											X																					X	
																				X																							



## SERVICES

### SERVICES THAT DRIVE SAFETY, RELIABILITY AND PERFORMANCE

Flowserve offers a comprehensive suite of services designed to provide unprecedented value and cost savings throughout the life span of the system. By integrating hydraulic, mechanical and materials engineering knowledge with real-world operating and practical business solutions, Flowserve helps customers:

- Increase equipment reliability
- Optimize asset uptime and performance
- Improve plant and personnel safety
- Lower total cost of maintenance



### PARTS, REPAIRS, UPGRADES AND FIELD SERVICES

Investments in well-equipped Quick Response Centers, mobile service fleets, and advanced manufacturing technologies along with the unrivaled expertise of its engineers, technicians and craftsmen enable Flowserve to address virtually every service requirement for process equipment, on- or off-site, regardless of OEM.

- **Repair and Upgrades** — From machining to mechanical upgrades to on-site management, Flowserve repairs and upgrades services to improve equipment performance while reducing downtime and costs.
- **Replacement Parts and Components** — Using its broad network of service and manufacturing centers, Flowserve supplies customers with the quality parts needed to keep operations running smoothly and profitably.
- **Field Services** — From maintenance to management, highly qualified Flowserve project managers, engineers and technicians can be deployed on-site to help your operations run smoothly.

## ENGINEERING AND TECHNICAL SERVICES

With world-class engineering and technical resources in more than 55 countries, Flowserve delivers value-added solutions that improve operational performance and increase profitability for its customers.

- **Technical Assessments** — Flowserve can perform system audits to identify operational issues that may be constraining output or elevating operating costs and recommended solutions.
- **Reliability Services** — Flowserve offers standard solutions to improve rotating equipment reliability while lowering cost of ownership.
- **Engineering Support** — Flowserve engineers can engage remotely or on-site to support grassroots project planning, system design or project management requirements.



## ASSET MANAGEMENT AND OPTIMIZATION

Flowserve continues to invest in capabilities and technologies to help customers realize more payback from their plant assets.

- **LifeCycle Advantage** — Through a combination of on-site assessments and technology, Flowserve experts help customers benchmark operational performance, define key metrics and implement solutions to achieve their long-term operational goals.
- **Intelligent Performance Solutions** — By employing sophisticated products, services and software to collect, examine and understand data, Flowserve helps customers use predictive analytics to take action and improve asset reliability.

## EDUCATION AND TRAINING

Flowserve offers a wide range of innovative programs to help plant operators, reliability specialists, engineers and maintenance personnel deepen their understanding of critical equipment and processes.

- **Learning Resource Center** — At its state-of-the-art Learning Resource Centers, Flowserve provides hands-on training and instruction in the principles of equipment operation, maintenance and reliability.
- **Customer On-site Training** — Flowserve can design, develop, and deliver training programs tailored specifically around the people, equipment and processes at a customer's facility.
- **Online Training** — Flowserve offers web-based modules with online testing and reporting to ensure comprehension of the most important principles.



## MECHANICAL SEALS AND SYSTEMS

The applications just keep getting tougher. Higher pressures and temperatures. More corrosive and erosive fluids. So, Flowserve continues to redefine the way mechanical seals operate by developing some of the most advanced seal modeling, design, and manufacturing capabilities in the world. These pioneering techniques have led to sophisticated seal face topographies and innovative microfeatures that actually boost your bottom line and make Flowserve seals the industry's choice for the most demanding environments.

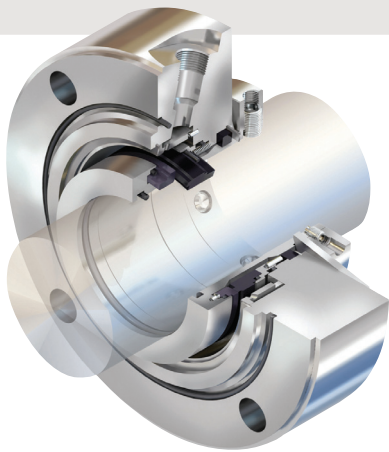

### STANDARD CARTRIDGE

No matter how hard you run your system, Flowserve ISC2 standard cartridge seals are up to the task. They're versatile enough to support hundreds of pump models from global manufacturers while meeting all international standards (ASME, DIN, ISO, JIS, and others). You'll also keep costs low with easy installation, less inventory, greater flexibility, less downtime and longer service life.

### PUSHER

Cost-effective and versatile, you'll find Flowserve pusher seals in a wide variety of applications and industries. From general services and light hydrocarbons to high-pressure and high-speed applications, they provide extended reliability and rugged durability you can count on. What's more, they have a proven reputation for easy repairs that return them to service quickly.

### METAL BELLOWS

Flowserve metal bellows seals provide proven reliability and long-term performance in general and critical services. Edge-welded, high-alloy bellows get the job done where corrosive chemicals degrade elastomers and other dynamic gaskets. Our global customers will find a variety of arrangements, including models that are fully compliant with API 682, to meet their toughest sealing requirements.

### MIXER

Flowserve mixer seals are designed to handle significant radial and axial shaft run-out while keeping workers safe and protecting the environment. Cost-effective performance, safety and reliability are engineered into every seal so total costs stay low. Choose from a variety of cartridge or split designs for top-, side- or bottom-entry installations or have seals custom-tailored to your specifications.

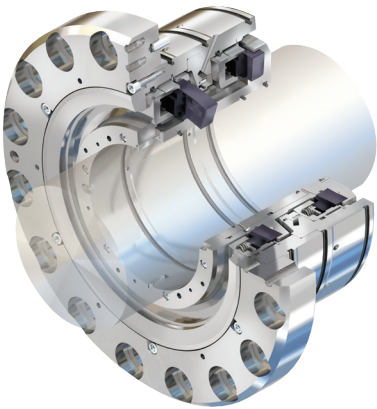

## COMPRESSOR SEALS AND SYSTEMS

Our Gaspac, Circpac, and Turbopac seals have earned their reputation as the most advanced compressor sealing solutions available. Even more, they're backed by a global team that leads the industry in dry gas seal retrofits, seal support engineering and world-class gas conditioning systems. With leading-edge technologies and service, Flowserve helps compressor customers reach higher pressure, efficiency and profitability.

## SLURRY

Slurry applications can be brutal on equipment, but Flowserve slurry seals are engineered to last. From economical designs for low-solids applications to rugged beasts that handle up to 60% solids content by weight, Flowserve slurry seals resist clogging with smooth geometries and non-wetted springs. Costs are controlled with modular components that make field repair easy.

## GAS BARRIER AND CONTAINMENT

Flowserve gas barrier seals have non-contacting seal faces that lift off during operation — wet or dry — so they run safely and reliably no matter what's happening in the chamber. They also use less power and simplified support systems. Flowserve containment seals normally run dry, handling process liquid during upset events while providing backup for inboard seals and proactive safety. Both designs offer significant cost and environmental advantages.

## OEM AND SPECIAL DUTY

Flexibility, reliability and low total cost are fundamental to the general industrial and specialty equipment requirements of OEMs. And Flowserve delivers. Global OEM customers will find a variety of mechanical seals developed specifically with OEMs in mind. We can even help with custom designs.

## SEAL SUPPORT SYSTEMS

Flowserve employs a specialized engineering team with years of experience designing and selecting seal support systems to suit applications and customer requirements. With a full range of products that meet ASME, API, PED, ISO and NR13 design criteria, Flowserve has you covered.

## ACCESSORIES

From cyclone separators to labyrinth bearing isolators, Flowserve seal accessories help enhance long-term reliability, longevity and safety while minimizing maintenance and downtime.





## OTHER FLOWSERVE PRODUCTS

Flowserve has the products, systems and expertise to help processes run smarter, safer and more efficiently. In addition to its extensive pump and seal portfolios, Flowserve offers high-quality valves, actuation and instrumentation.



### VALVES

Flowserve valves are found in the world's toughest industries, where reliable performance is the only option. High temperatures, ultra-high pressures, erosion and corrosion are at the core of the dozens of leading brands that comprise our broad valve portfolio.



### ACTUATION & INSTRUMENTATION

From positioners and switches to remotely controlled, fully automated electric, hydraulic and pneumatic actuators, customers depend on the full range of intelligent automation solutions from Flowserve to help their processes run smarter, safer and more efficiently.



## WHEN AND WHERE YOU NEED US

Our network of manufacturing facilities, design centers of excellence, strategically located Quick Response Centers and customer on-site resources means customers never have to look far for support.



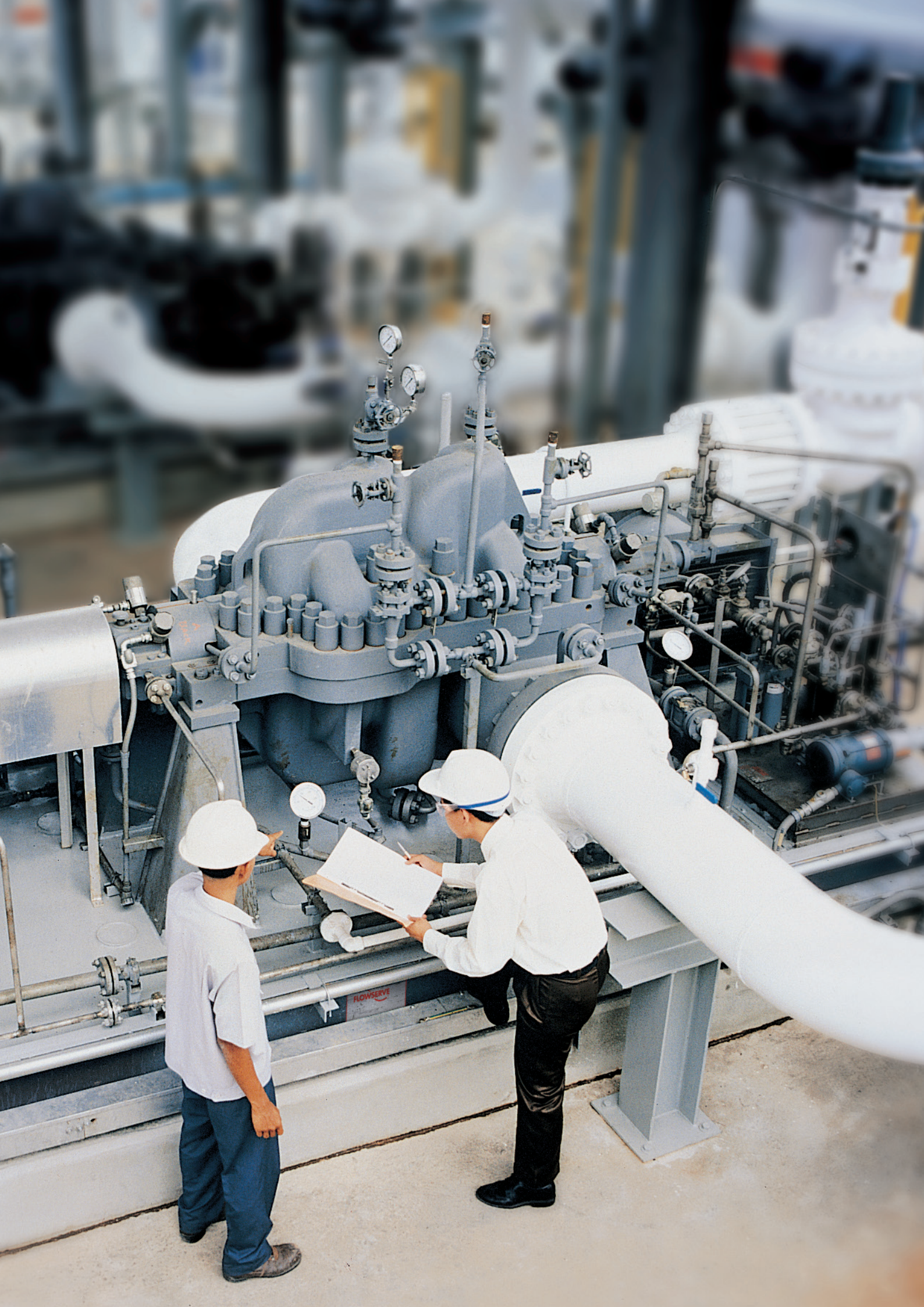

# PUMPS

Overhung . . . . .	20
Between Bearings . . . . .	36
Vertical . . . . .	50
Positive Displacement. . . . .	62
Side Channel . . . . .	68
Vacuum Pumps & Compressors . . . . .	76
Specialty Products . . . . .	82

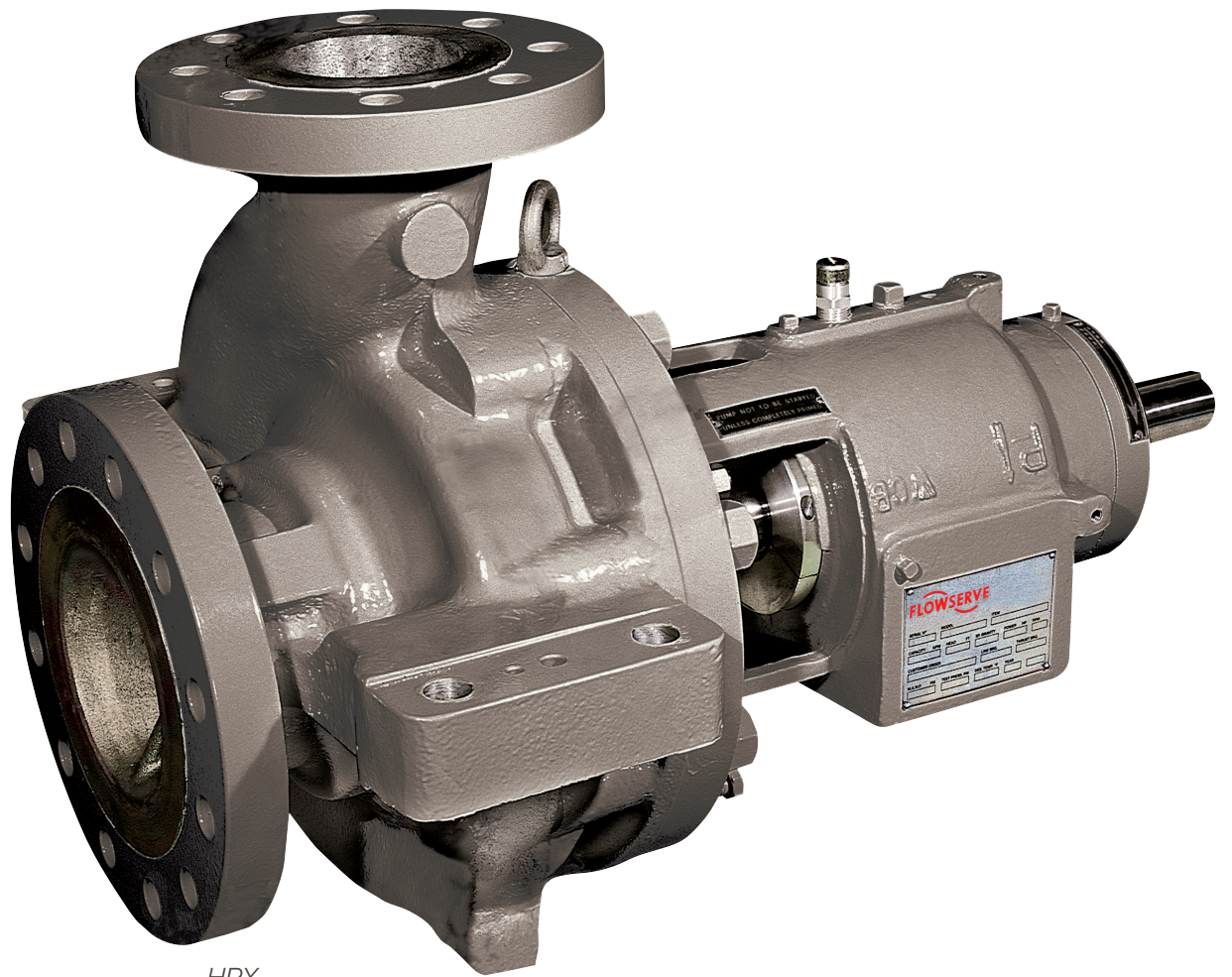

HPX

## OVERHUNG

Reliable, efficient performance across a full range of applications, from highly aggressive chemicals and solids to high-temperature process applications: that's what's engineered into every Flowserve overhung pump. Our global customers will find a range of metallic and non-metallic pumps built to every important global standard. Extended life is achieved through careful attention to details, from critical impeller clearances to mechanical seal operating environments to rugged power end bearing arrangements. Plus, maintenance-friendly features help get pumps back in service quickly.

### Overhung – Quick Reference\*

Product	Sub-Type	Flows to	Heads to	Pressures to	Temperatures
<b>Mark 3™ ISO</b>	Chemical Process ASME, ISO	1400 m <sup>3</sup> /h (6160 gpm)	220 m (720 ft)	25 bar (362 psi)	-80°C to 400°C (-110°F to 750°F)
<b>Mark 3 ASME</b>	Chemical Process ASME, ISO	4540 m <sup>3</sup> /h (20 000 gpm)	215 m (700 ft)	27 bar (400 psi)	-73°C to 370°C (-100°F to 700°F)
<b>Guardian™</b>	Chemical Process ASME, ISO	375 m <sup>3</sup> /h (1650 gpm)	215 m (700 ft)	24 bar (350 psi)	to 290°C (550°F)
<b>TB-MAG™</b>	Chemical Process ASME, ISO	360 m <sup>3</sup> /h (1585 gpm)	153 m (500 ft)	25 bar (362 psi)	-29°C to 121°C (-20°F to 250°F)
<b>U-MAG™</b>	Chemical Process ASME, ISO	102 m <sup>3</sup> /h (450 gpm)	50 m (165 ft)	20 bar (300 psi)	-29°C to 121°C (-20°F to 250°F)
<b>CBE and CBM</b>	Chemical Process ASME, ISO	650 m <sup>3</sup> /h (2862 gpm)	150 m (492 ft)	25 bar (362 psi)	-40°C to 300°C (-40°F to 572°F)
<b>CBT</b>	Chemical Process ASME, ISO	2200 m <sup>3</sup> /h (9686 gpm)	160 m (524 ft)	25 bar (362 psi)	-20°C to 350°C (-4°F to 662°F)

\* Additional products shown on next two pages

## Overhung – Quick Reference, cont'd.

Product	Sub-Type	Flows to	Heads to	Pressures to	Temperatures
<b>D800</b>	Industrial Process	455 m <sup>3</sup> /h (2000 gpm)	150 m (500 ft)	15 bar (220 psi)	to 120°C (250°F)
<b>MEN and MENBLOC</b>	Industrial Process	800 m <sup>3</sup> /h (3520 gpm)	140 m (450 ft)	16 bar (230 psi)	-10°C to 120°C (15°F to 250°F)
<b>ME</b>	Industrial Process	3000 m <sup>3</sup> /h (13 208 gpm)	110 m (361 ft)	16 bar (230 psi)	to 120°C (250°F)
<b>DS</b>	Industrial Process	5700 m <sup>3</sup> /h (25 000 gpm)	110 m (350 ft)	27 bar (400 psi)	to 120°C (250°F)
<b>ZLN, ZLK and ZLI</b>	Industrial Process	1800 m <sup>3</sup> /h (7925 gpm)	140 m (459 ft)	16 bar (232 psi)	to 170°C (338°F)
<b>ZTN, ZTK and ZTI</b>	Industrial Process	1000 m <sup>3</sup> /h (4403 gpm)	95 m (311 ft)	16 bar (232 psi)	to 350°C (662°F)
<b>ZEN, ZDN, ZHN and ZDI</b>	Industrial Process	600 m <sup>3</sup> /h (2642 gpm)	90 m (295 ft)	40 bar (580 psi)	to 230°C (446°F)
<b>DBS</b>	Industrial Process	1200 m <sup>3</sup> /h (5283 gpm)	100 m (328 ft)	10 bar (145 psi)	to 110°C (230°F)
<b>SMP</b>	Industrial Process	135 m <sup>3</sup> /h (600 gpm)	70 m (220 ft)	12 bar (175 psi)	-40°C to 120°C (-40°F to 250°F)
<b>F-Line</b>	Industrial Process	500 m <sup>3</sup> /h (2200 gpm)	250 m (820 ft)	25 bar (362 psi)	to 105°C (220°F)
<b>MVE</b>	Industrial Process	2700 m <sup>3</sup> /h (11 890 gpm)	15 m (50 ft)	7 bar (100 psi)	to 100°C (212°F)
<b>FRBH</b>	Industrial Process	9085 m <sup>3</sup> /h (40 000 gpm)	100 m (330 ft)	14 bar (200 psi)	to 150°C (300°F)
<b>MPT</b>	Solids Handling	600 m <sup>3</sup> /h (2650 gpm)	35 m (115 ft)	5 bar (72 psi)	to 75°C (165°F)
<b>MF and MFV</b>	Solids Handling	600 m <sup>3</sup> /h (2650 gpm)	90 m (300 ft)	19 bar (275 psi)	to 63°C (145°F)
<b>MN and MNV</b>	Solids Handling	45 500 m <sup>3</sup> /h (200 000 gpm)	90 m (300 ft)	17 bar (240 psi)	to 63°C (145°F)
<b>MSX</b>	Solids Handling	4545 m <sup>3</sup> /h (20 000 gpm)	90 m (300 ft)	11 bar (160 psi)	to 40°C (104°F)

Product	Sub-Type	Flows to	Heads to	Pressures to	Temperatures
<b>M</b>	Slurry	10 000 m <sup>3</sup> /h (44 000 gpm)	90 m (300 ft)	10 bar (150 psi)	to 120°C (250°F)
<b>R</b>	Slurry	10 000 m <sup>3</sup> /h (44 000 gpm)	50 m (160 ft)	10 bar (150 psi)	to 110°C (225°F)
<b>Titan-Slurry™</b>	Slurry	3600 m <sup>3</sup> /h (16 000 gpm)	90 m (300 ft)	40 bar (580 psi)	to 110°C (230°F)
<b>LC</b>	Slurry	8000 m <sup>3</sup> /h (35 200 gpm)	90 m (300 ft)	25 bar (360 psi)	to 140°C (285°F)
<b>HPX</b>	API Process	2000 m <sup>3</sup> /h (8800 gpm)	350 m (1100 ft)	80 bar (1160 psi)	-160°C to 450°C (-250°F to 842°F)
<b>PHL</b>	API Process	900 m <sup>3</sup> /h (3963 gpm)	400 m (1312 ft)	40 bar (600 psi)	to 450°C (842°F)
<b>ERP</b>	API Process	1100 m <sup>3</sup> /h (4800 gpm)	230 m (755 ft)	60 bar (870 psi)	-50°C to 350°C (-158°F to 660°F)
<b>PVXM</b>	API Process	500 m <sup>3</sup> /h (2200 gpm)	275 m (900 ft)	40 bar (600 psi)	-100°C to 250°C (-148°F to 480°F)
<b>HWMA</b>	API Process	45 m <sup>3</sup> /h (200 gpm)	440 m (1445 ft)	64 bar (930 psi)	-46°C to 260°C (-51°F to 500°F)
<b>PVML</b>	API Process	500 m <sup>3</sup> /h (2220 gpm)	275 m (900 ft)	40 bar (580 psi)	-100°C to 250°C (-148°F to 480°F)
<b>MSP</b>	API Process	34 m <sup>3</sup> /h (150 gpm)	900 m (2955 ft)	64 bar (930 psi)	-46°C to 250°C (-51°F to 482°F)
<b>HWX</b>	API Process	1300 m <sup>3</sup> /h (5725 gpm)	370 m (1215 ft)	42 bar (610 psi)	-46°C to 400°C (-51°F to 750°F)
<b>HPX6000 and HPXM6000</b>	API Process	3409 m <sup>3</sup> /h (15 000 gpm)	244 m (800 ft)	83 bar (1200 psi)	-20°C to 400°C (-30°F to 826°F)
<b>AFH9000</b>	Axial Flow	34 065 m <sup>3</sup> /h (150 000 gpm)	11 m (36 ft)	10.3 bar (150 psi)	20°C to 149°C (-30°F to 300°F)

# OVERHUNG

## CHEMICAL PROCESS – ASME, ISO

### Mark 3 ISO



Durco

ISO 2858/5199 compliant pump for corrosive applications in chemical, hydrocarbon and pharmaceutical processing requiring unmatched reliability, outstanding hydraulic performance and increased pump availability.

- Lower total cost of pump ownership resulting from simplified maintenance and extended bearing and seal life associated with reverse vane impeller
- Increased reliability and mechanical seal life due to the ideal seal environment created by the SealSentry™ seal chamber
- Simplified maintenance with two-piece power end featuring self-contained bearing housing and external impeller adjustment mechanism
- Optimal, predictable seal chamber pressure that is established after every impeller setting

#### SPECIFICATIONS

Flows to: 1400 m<sup>3</sup>/h (6160 gpm)  
Heads to: 220 m (720 ft)  
Press. to: 25 bar (362 psi)  
Temp: -80°C to 400°C  
(-110°F to 750°F)

Refer to literature PS-10-31  
at [flowserve.com/library](http://flowserve.com/library).

## CHEMICAL PROCESS – ASME, ISO

### Mark 3 ASME



Durco

ASME B73.1 chemical process pump for corrosive applications in chemical, petrochemical, hydrocarbon and pharmaceuticals processing requiring unequaled efficiency, extended life and repeatable pump performance.

- Lower total cost of ownership from reverse vane impeller, which eases maintenance and provides renewable, high-efficiency performance over the pumps' life
- Increased reliability and mechanical seal life due to the ideal seal environment created by the SealSentry seal chamber
- Ease of maintenance resulting from optimal, predictable seal chamber pressures that are re-established after every impeller setting
- Extended mechanical seal and bearing life through robust shaft and bearing designs that also minimize shaft deflection

#### SPECIFICATIONS

Flows to: 4540 m<sup>3</sup>/h (20 000 gpm)  
Heads to: 215 m (700 ft)  
Press. to: 27 bar (400 psi)  
Temp: -73°C to 370°C  
(-100°F to 700°F)

Refer to literature PS-10-13  
at [flowserve.com/library](http://flowserve.com/library).

## CHEMICAL PROCESS – ASME, ISO

### Guardian



Durco

Metallic sealless magnetic drive pump compliant with ASME B73.1, ASME B73.3 and HI 5.1-5.6 that is designed for applications requiring efficient performance and emissions-free reliability.

- Optimal performance through a highly engineered internal lubrication flow paths designed to maximize cooling of the bushings and journals
- Ease of maintenance due to standard and contained back pullout, allowing the casing to stay in-line and piping connections to remain intact
- Higher process temperature range capabilities with the use of strong samarium cobalt rare earth magnets in the couplings
- Longer service life resulting from silicon carbide bushings and journals that resist wear and corrosion

#### SPECIFICATIONS

Flows to: 375 m<sup>3</sup>/h (1650 gpm)  
Heads to: 215 m (700 ft)  
Press. to: 24 bar (350 psi)  
Temp: to 290°C (550°F)

Refer to literature PS-10-14  
at [flowserve.com/library](http://flowserve.com/library).



## CHEMICAL PROCESS – ASME, ISO

## TB-MAG

ASME B73.3 and ISO 2858 compliant thrust-balanced, fluoropolymer-lined, magnetic drive pump for chemical processing, metals and other industries seeking outstanding leak protection and reliability.



INNOMAG

- Efficient performance over the entire flow range is achieved by means of a dynamic thrust balancing system that eliminates the need for thrust bearings
- Application versatility due to ability to handle solids to 30% by volume
- Expedited, lower-cost maintenance due to standard and contained back pullout, allowing the casing to stay in-line and piping connections to remain intact
- Longer service life resulting from silicon carbide back wear rings that restrict solids larger than 0.127 mm from entering the containment shell and double-sealed inner magnetic assembly to protect against corrosive permeation

## SPECIFICATIONS

Flows to: 360 m<sup>3</sup>/h (1585 gpm)  
Heads to: 153 m (500 ft)  
Press. to: 25 bar (362 psi)  
Temp: -29°C to 121°C  
(-20°F to 250°F)

Refer to literature PS-10-36  
at [flowserve.com/library](http://flowserve.com/library).

## CHEMICAL PROCESS – ASME, ISO

## U-MAG

Versatile fluoropolymer-lined, magnetic drive pump for smaller-volume applications needing exceptional safety, enhanced performance and highest purity standards.



INNOMAG

- Application versatility derived from numerous mounting drive options to accommodate site-specific requirements, including gasoline engines for portable and remote chemical transfer, trunk unloading, or skid or cart operation
- Longer service life due to EFTE or optional ultra-high purity PFA construction that offers excellent chemical resistance
- Regulatory compliance resulting from outstanding leak protection and the CE mark, making it compliant with directives such as ATEX

## SPECIFICATIONS

Flows to: 102 m<sup>3</sup>/h (450 gpm)  
Heads to: 50 m (165 ft)  
Press. to: 20 bar (300 psi)  
Temp: -29°C to 121°C  
(-20°F to 250°F)

Refer to literature PS-10-37  
at [flowserve.com/library](http://flowserve.com/library).

## CHEMICAL PROCESS – ASME, ISO

## CBE and CBM

Modular process pumps with hydraulics, closed impellers, and magnetic couplings for bare shaft (CBM) or close-coupled (CBE) configurations. Meets all ISO 5199, ISO 15783 and ISO 2858 requirements.



SIHI

- Increased reliability enabled by constant cooling and lubrication flow, protected samarium cobalt magnets and containment shell
- Reduced spare parts costs derived from interchangeability of the back pullout assemblies
- Improved reliability and reduced installation cost thanks to low net positive suction head (NPSH) value
- Broad application diversity made possible by CBE heat barrier option for temperatures up to 400°C (752°F)

## SPECIFICATIONS

Flows to: 650 m<sup>3</sup>/h (2862 gpm)  
Heads to: 150 m (492 ft)  
Press. to: 25 bar (362 psi)  
Temp: -40°C to 300°C  
(-40°F to 572°F)

Refer to literature PS-10-42  
at [flowserve.com/library](http://flowserve.com/library).

# OVERHUNG

## CHEMICAL PROCESS – ANSI, ISO

### CBT

Single-stage pump with ISO 2858/5199 design features and nominal rating. Engineered for applications in chemical, petrochemical and pharmaceuticals processing with flows beyond the range defined by ISO 2858.

- Low total cost of pump ownership from simplified maintenance enabled by a design that permits dismantling without disconnecting the pump casing from pipework
- Broad application flexibility and low inventory carrying costs from diverse material options and 21 sizes, with only four different bearing brackets for maximum interchangeability
- High-temperature performance — exceeding 200°C (392°F) — possible with centerline mounted option, which minimizes distortion and pipe loads

#### SPECIFICATIONS

Flows to 2200 m<sup>3</sup>/h (9686 gpm)  
Heads to: 160 m (524 ft)  
Press. to: 25 bar (362 psi)  
Temp: -20°C to 350°C  
(-4°F to 662°F)



SIHI

## INDUSTRIAL PROCESS

### D800

Versatile and cost-effective general industry pumps with ASME B16.1 casing nozzles. Available in frame-mounted (D814) and close-coupled (D824) configurations.

- Increased uptime enabled by a precision dry-rabbit fit with one-piece adapter and seal cover to ensure positive alignment
- Easy maintenance and assembly facilitated by pre-set mechanical seal assembly on the shaft sleeve
- Improved energy efficiency due to a precision-cast, high-efficiency closed impeller that is statically and hydraulically balanced to reduce power consumption
- Low operating costs and extended pump life provided by renewable wear rings and shaft sleeves that restore worn operating clearances

#### SPECIFICATIONS

Flows to: 455 m<sup>3</sup>/h (2000 gpm)  
Heads to: 150 m (500 ft)  
Press. to: 15 bar (220 psi)  
Temp: to 120°C (250°F)  
Refer to literature PSS-10-6.1  
at [flowserve.com/library](http://flowserve.com/library).



Worthington

## INDUSTRIAL PROCESS

### MEN and MENBLOC

Reliable, efficient frame-mounted (MEN) and close-coupled (MENBLOC) general industry pumps for water supply and treatment, light chemical and general industry applications. Meets European Regulation No. 547/2012.

- High efficiency through a precision-cast, closed impeller with machine shrouds and balance holes that also minimize axial thrust
- Performance reliability due to an integral, one-piece cast iron bearing frame that provides excellent rigidity and concentricity to minimize vibration
- Optimized hydraulics and components meet European Regulation No. 547/2012
- Versatility through a wide hydraulic range, multiple configurations, parts interchangeability and materials options
- Ease of maintenance and inspection resulting from a back pullout design

#### SPECIFICATIONS

Flows to: 800 m<sup>3</sup>/h (3520 gpm)  
Heads to: 140 m (450 ft)  
Press. to: 16 bar (230 psi)  
Temp: -10°C to 120°C  
(15°F to 250°F)

Refer to literature PS-10-2  
at [flowserve.com/library](http://flowserve.com/library).

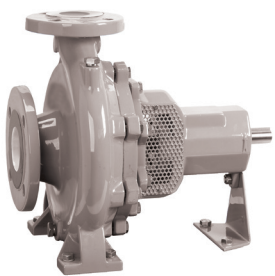

IDP

Worthington

## INDUSTRIAL PROCESS

## ME



Flowserve

High-capacity, reliable frame-mounted pump for water supply and treatment, light chemical and general industry applications that need high flow rates. Meets European Regulation No. 547/2012.

- Optimized for high-capacity performance via one-piece casing with tangential discharge
- High efficiency enabled by a precision-cast, closed impeller with machine shrouds and balance holes that also minimize axial thrust
- Low cost of ownership made possible by an open-seal chamber with integral vortex-breaking ribs to extend the mechanical seal life
- Ease of maintenance and inspection resulting from a back pullout design

## SPECIFICATIONS

Flows to: 3000 m<sup>3</sup>/h (13 208 gpm)  
Heads to: 110 m (361 ft)  
Press. to: 16 bar (230 psi)  
Temp. to: 120°C (250°F)

Refer to literature PS-10-2  
at [flowserve.com/library](http://flowserve.com/library).

## INDUSTRIAL PROCESS

## DS

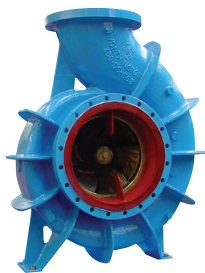

Worthington

Versatile end suction pump for mining, water resources, power generation and general industry applications requiring lower operational and maintenance costs.

- Increased uptime made possible by a mechanically balanced, radial flow impeller that includes balance holes to minimize axial thrust and extend the life of the seal
- Higher efficiency enabled by a double volute configuration that greatly reduces radial forces over single-volute counterparts
- Flexibility provided by a seal chamber that accommodates a wide choice of sealing arrangements, from packing to mechanical seal types
- Ease of maintenance and inspection resulting from a back pullout design

## SPECIFICATIONS

Flows to: 5700 m<sup>3</sup>/h (25 000 gpm)  
Heads to: 110 m (350 ft)  
Press. to: 27 bar (400 psi)  
Temp. to: 120°C (250°F)

## INDUSTRIAL PROCESS

## ZLN, ZLK and ZLI

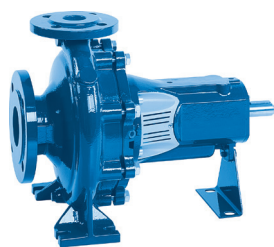

SIHI

Volute-style pumps for use with clear or turbid liquids that are free of solid particles. Available in bare shaft (ZLN), compact (ZLK) or inline (ZLI) configurations, all meeting EN 733 and ISO 9908.

- Ease of maintenance assured by design that enables key components of each unit to be removed and serviced without disturbing the attached pipe work
- Broad application flexibility enabled by more than 50 sizes, plus a wide range of material and configuration options
- Reduced operating cost via low net positive suction head (NPSH), high reliability and high efficiency

## SPECIFICATIONS

Flows to: 1800 m<sup>3</sup>/h (7925 gpm)  
Heads to: 140 m (459 ft)  
Press. to: 16 bar (232 psi)  
Temp. to: 170°C (338°F)

Refer to literature PS-10-40.  
at [flowserve.com/library](http://flowserve.com/library).

# OVERHUNG

## INDUSTRIAL PROCESS

### ZTN, ZTK and ZTI

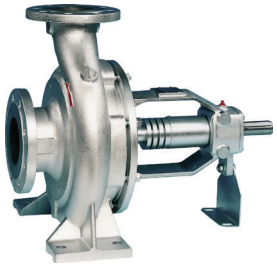

SIHI

Volute pumps developed specifically for handling mineral and synthetic heat transfer oils, compliant with dimensions and nominal rating according to EN 733. Choose from bare shaft (ZTN), compact (ZTK) or inline (ZTI) units.

- Ease of maintenance assured by design that enables key components to be removed and serviced without removing pump casing from attached pipe work
- Broad application versatility via multiple sizes, materials and configurations; ZTN usable in installations with positive or negative suction pressure
- Lower lifetime cost of ownership from space-saving and easy-to-install compact and inline designs

#### SPECIFICATIONS

Flows to: 1000 m<sup>3</sup>/h (4403 gpm)  
Heads to: 95 m (311 ft)  
Press. to: 16 bar (232 psi)  
Temp. to: 350°C (662°F)

Refer to literature PS-10-41  
at [flowserve.com/library](http://flowserve.com/library).

## INDUSTRIAL PROCESS

### ZEN, ZDN, ZHN and ZDI



SIHI

Volute casing pumps designed to meet the high demands of pumping hot water. Bare shaft (ZHN, ZDN, ZEN) or inline (ZDI) configurations available. Dimensions and nominal rating according to EN 733/EN 22858.

- Improved plant and personnel safety assured by a double heat barrier design
- Increased service life enabled by optimization of the high pressures and temperatures associated with hot water heat carrier systems, as well as the mechanical seal
- Ease of maintenance assured by designs that enable each unit type to be serviced without disturbing attached pipe work

#### SPECIFICATIONS

Flows to: 600 m<sup>3</sup>/h (2642 gpm)  
Heads to: 90 m (295 ft)  
Press. to: 40 bar (580 psi)  
Temp. to: 230°C (446°F)

Refer to literature EN 733/EN 22858  
at [flowserve.com/library](http://flowserve.com/library).

## INDUSTRIAL PROCESS

### DBS



SIHI

Non-clogging, volute-casing pumps designed for pumping dirty liquids or liquids with solids, with design features and nominal rating to ISO 2858 enlarged sizes.

- High performance, with dirty liquids assured by non-clogging design
- Ease of maintenance enabled by process design that permits dismantling of complete bearing unit without disconnecting pump casing from piping
- Broad application flexibility made possible by multiple impeller shapes — including double-channel, triple-channel and free-flow — plus diverse configuration, size and material options

#### SPECIFICATIONS

Flows to: 1200 m<sup>3</sup>/h (5283 gpm)  
Heads to: 100 m (328 ft)  
Press. to: 10 bar (145 psi)  
Temp. to: 110°C (230°F)

## INDUSTRIAL PROCESS

## SMP



IDP

Economical and reliable frame-mounted, single-stage, standard motor pump for water supply, water treatment, HVAC and chiller applications.

- Low operating costs achieved through use of high-efficiency, semi-open or closed impellers that are keyed to shaft for positive drive
- Flexibility and reduced inventory carrying costs due to use of industry-standard NEMA motors
- Reliable performance with minimal leakage enabled by a self-aligned mechanical seal that is positioned by the impeller and keeps pump fluid away from the motor
- Ease of maintenance resulting from a back pullout design that facilitates inspection and a stub shaft design that allows shaft replacement in the field

## SPECIFICATIONS

Flows to: 135 m<sup>3</sup>/h (600 gpm)  
 Heads to: 70 m (220 ft)  
 Press. to: 12 bar (175 psi)  
 Temp: -40°C to 120°C  
 (-40°F to 250°F)

Refer to literature PS-10-26  
 at [flowserve.com/library](http://flowserve.com/library).

## INDUSTRIAL PROCESS

## F-Line

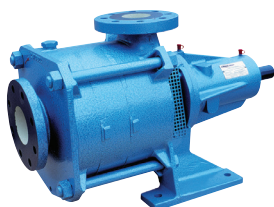

Flowserve

The F-Line is a family of multistage, overhung pumps with excellent hydraulic efficiency and high suction lift capability, making them ideal for high-pressure water applications.

- Improved performance via multistage, overhung construction that enables better suction performance while simplifying pipe work layout
- Ease of maintenance with a back pullout design that facilitates inspection
- Longer service life due to an oversized shaft conservatively designed to minimize deflection and reduce wear
- Application flexibility provided by modular platform with numerous available horizontal and vertical configurations that permits accurate sizing for operating conditions and site requirements

## SPECIFICATIONS

Flows to: 500 m<sup>3</sup>/h (2200 gpm)  
 Heads to: 250 m (820 ft)  
 Press. to: 25 bar (362 psi)  
 Temp: to 105°C (220°F)

## Simple and Accurate Pump Selection

Eliminate pump selection and sizing confusion with Affinity™ Portal. This free web-based tool gives you immediate access to the latest, most accurate data on Flowserve pumps. Use it to size a pump for a new application or get performance information for an existing unit. You can also save selections and generate technical documents specific for your hydraulic selection. **Register today at [www.flowserve.com/affinity](http://www.flowserve.com/affinity).**



# OVERHUNG

## INDUSTRIAL PROCESS

### MVE



TKL

High-efficiency, reliable mixed-flow, single-stage volute pump for industrial, municipal and agricultural applications requiring high suction.

- Low total cost of ownership enabled by multistage, overhung construction that enables better suction performance while simplifying pipe work layout at installation
- Increased reliability due to single-volute, symmetrical casing that features integral suction and discharge flanges for high strength to resist pipe loads
- Extended seal and bearing life made possible by mixed-flow, enclosed impeller that is mechanically balanced to prevent vibration
- Ease of maintenance resulting from a back pullout design to facilitate inspection and permit removal without disturbing piping

#### SPECIFICATIONS

Flows to: 2700 m<sup>3</sup>/h (11 890 gpm)  
Heads to: 15 m (50 ft)  
Press. to: 7 bar (100 psi)  
Temp: to 100°C (212°F)

## INDUSTRIAL PROCESS

### FRBH

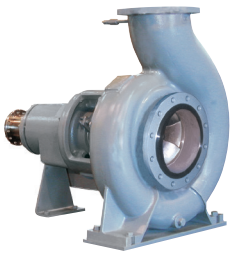

Worthington

Heavy-duty paper stock pump designed primarily for pulp and paper applications, but also has considerable use in the chemical processing, mining, water resources, and oil and gas industries.

- High uptime and efficiency ensured by unobstructed suction, large streamlined flow channel, and semi-open impeller with back pump-out vanes, which prevent air binding and clogging, even in thick, pulpy mixtures
- Reduced maintenance provided by rigid one-piece bearing frame; ensures positive alignment and offers ample access to gland and seal chamber
- Reliable, efficient performance with a steep head-capacity curve, which prevents driver overload and minimizes changes in flow, despite changes in system head
- Low total cost of ownership resulting from high-efficiency, low-maintenance design

#### SPECIFICATIONS

Flows to: 9085 m<sup>3</sup>/h (40 000 gpm)  
Heads to: 100 m (330 ft)  
Press. to: 14 bar (200 psi)  
Temp: to 150°C (300°F)

Refer to literature PS-10-16 at [flowserve.com/library](http://flowserve.com/library).

## SOLIDS HANDLING

### MPT



Flowserve

Rugged self-priming, solids-handling pump designed to deliver reliable peak performance and low costs to the demanding water resources and mining industries.

- Longer service life derived from the use of rugged, heavy-duty volute casing
- Reduced downtime provided by abrasion-resistant, double mechanical seal with silicon carbide faces that prevent contaminants from entering seal chamber
- Increased uptime through the external impeller adjustment via four bushings that allow clearances to be accurately reset
- Ease of maintenance enabled by back pullout design, which includes a replaceable seal housing that facilitates maintenance without disturbing the piping

#### SPECIFICATIONS

Flows to: 600 m<sup>3</sup>/h (2650 gpm)  
Heads to: 35 m (115 ft)  
Press. to: 5 bar (72 psi)  
Temp: to 75°C (165°F)

Refer to literature PS-10-9 at [flowserve.com/library](http://flowserve.com/library).

## SOLIDS HANDLING

## MF and MFV



Worthington

Rugged and efficient solids-handling pump designed specifically for reliability, low cost and long life in demanding sewage handling services or where suspended solids are of particular concern.

- Ease of maintenance enabled by the removable gland, which simplifies packing adjustment and replacement, plus readily accessible lubrication points
- Broad application versatility provided by a wide variety of mechanical seal options and design of the stuffing box, which allows for either grease or water seal
- Low maintenance costs due to conservative bearing design that eliminates radial and axial play, as well as supports that minimize vibration and ensure rigidity

## SPECIFICATIONS

Flows to: 600 m<sup>3</sup>/h (2650 gpm)  
Heads to: 90 m (300 ft)  
Press. to: 19 bar (275 psi)  
Temp: to 63°C (145°F)

Refer to literature PS-10-3  
at [flowserve.com/library](http://flowserve.com/library).

## SOLIDS HANDLING

## MN and MNV



Worthington

Rugged, large-capacity, mixed-flow, solids-handling pump designed specifically for demanding sewage handling services or where suspended solids are of particular concern.

- Application versatility provided by a design that includes horizontal and vertical models, a variety of nozzle positions, and direct or independent motor mounting
- Increased uptime enabled by oversized shaft and reduced overhang, which minimize shaft deflection and increase packing or seal life
- High-efficiency performance enabled by adjustable, double-chrome steel wear rings
- Reduced maintenance with back pullout design, removable gland, replaceable shaft sleeves, and readily accessible lubrication points in bearing housing

## SPECIFICATIONS

Flows to: 45 500 m<sup>3</sup>/h (200 000 gpm)  
Heads to: 90 m (300 ft)  
Press. to: 17 bar (240 psi)  
Temp: to 63°C (145°F)

Refer to literature PS-10-4  
at [flowserve.com/library](http://flowserve.com/library).

## SOLIDS HANDLING

## MSX



IDP

The MSX solids-handling submersible pump is engineered to perform efficiently in the most challenging environments, from pumping raw sewage to moving industrial wastewater and solids-laden liquids.

- Low operating costs enabled by EPACT-rated motor and high-efficiency hydraulics that reduce energy consumption while providing predictable pumping performance
- Reliability with spike-resistant windings that provide smooth, consistent motor performance and the ability to handle voltage spikes
- Increased uptime via dynamically balanced shaft and rotor for reduced vibration and smooth operation
- Long service life provided by watertight cable entry that protects motor from moisture and contamination

## SPECIFICATIONS

Flows to: 4545 m<sup>3</sup>/h (20 000 gpm)  
Heads to: 90 m (300 ft)  
Press. to: 11 bar (160 psi)  
Temp: to 40°C (104°F)

Refer to literature PS-50-2-E  
at [flowserve.com/library](http://flowserve.com/library).

# OVERHUNG

## SLURRY

### M



Worthington

Hard-metal slurry pump designed to handle high concentrations of coarse, abrasive solids in suspension. Well-suited for the harshest applications in mining, mineral processing and metal production.

- Long service life and outstanding abrasion and corrosion resistance provided by high-chrome iron casing with tangential discharge
- Increased uptime provided by closed impeller with external pumping vanes, which extend seal life by reducing stuffing box pressure and suction recirculation
- Reliable performance with minimal maintenance facilitated by three-point external end-clearance adjustment that restores impeller clearance to optimize efficiency without shims
- Reduced inventory costs due to interchangeability among the configurations

#### SPECIFICATIONS

Flows to: 10 000 m<sup>3</sup>/h (44 000 gpm)

Heads to: 90 m (300 ft)

Press. to: 10 bar (150 psi)

Temp: to 120°C (250°F)

Refer to literature PS-10-19 at [flowserve.com/library](http://flowserve.com/library).

## SLURRY

### R

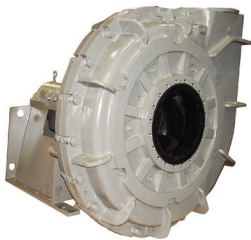

Worthington

Rubber-lined slurry pump engineered to handle high concentrations of fine abrasive solids in suspension or corrosive/abrasive mixtures often found in the mining and metal processing industries.

- Long service life provided by abrasion- and corrosion-resistant rubber casing liners, which are available in multiple materials to suit application requirements
- Ease of maintenance facilitated by radially split casing, which provides easy access to liners and ample stuffing box access
- Broad application versatility due to multiple configurations, choice of materials, parts interchangeability and several shaft sealing options
- Increased uptime and reduced maintenance costs enabled by the closed impeller with pump-out vanes to reduce stuffing box pressure and suction recirculation

#### SPECIFICATIONS

Flows to: 10 000 m<sup>3</sup>/h (44 000 gpm)

Heads to: 50 m (160 ft)

Press. to: 10 bar (150 psi)

Temp: to 110°C (225°F)

Refer to literature PS-10-18 at [flowserve.com/library](http://flowserve.com/library).

## SLURRY

### Titan-Slurry

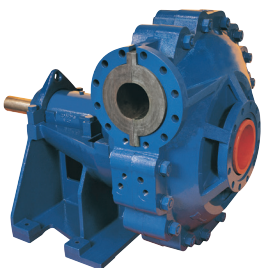

TKL

The Titan Slurry is a single-stage pump with a tangential discharge engineered to handle high concentrations of coarse, abrasive solids in suspension. Its unique dual case design uses either a hard metal or elastomeric liner.

- Broad application versatility and maximum wear resistance enabled by use of replaceable and interchangeable hard metal or elastomeric casing liners
- Reduced maintenance and low total cost of ownership made possible by unique radially split dual-casing design, which eases liner inspection and replacement
- Reduced energy costs provided by high-efficiency, closed-vane impeller with adjustable face clearance and generous wear allowance
- Increased uptime due to extra-thick wear allowances plus oversized shafts and bearings

#### SPECIFICATIONS

Flows to: 3600 m<sup>3</sup>/h (16 000 gpm)

Heads to: 90 m (300 ft)

Press. to: 40 bar (580 psi)

Temp: to 110°C (230°F)

Refer to literature PS-10-8 at [flowserve.com/library](http://flowserve.com/library).



## SLURRY

## LC



Flowserve

The LC pump is engineered to withstand high concentrations of abrasive and corrosive solutions, like those found in phosphoric and derived industries as well as mining and mineral processing.

- Extended service life due to thick-walled concentric casing with tangential discharge that is radially balanced and free from cavities and obstructions to minimize wear
- Increased mean time between repair enabled by impeller counter vanes that limit internal recirculation and reduce seal pressure to promote longer seal life
- Simplified maintenance with removable one-piece bearing frame
- Broad application versatility made possible by numerous shaft sealing, impeller and configuration options to meet application and installation requirements

## SPECIFICATIONS

Flows to: 8000 m<sup>3</sup>/h (35 200 gpm)  
 Heads to: 90 m (300 ft)  
 Press. to: 25 bar (360 psi)  
 Temp: to 140°C (285°F)

Refer to literature PS-10-11  
 at [flowserve.com/library](http://flowserve.com/library).

## API PROCESS

## HPX

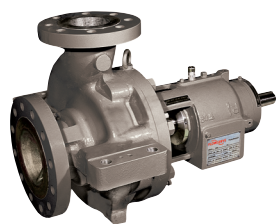

IDP

Fully compliant with ISO 13709/API 610 (OH2) design criteria, the HPX pump is the workhorse of the oil and gas and hydrocarbon processing industries, boasting unequaled versatility, reliability and safety.

- Lower operating costs due to comprehensive hydraulic coverage and numerous specialty configurations that permit precise selection for best operating efficiency
- Longer service life enabled by centerline-supported casing that withstands nozzle loads beyond ISO 13709/API 610 requirements and minimizes shaft misalignment, thereby extending rotor, bearing and seal life
- Stringent emissions containment with ISO 21049/API 682 seal chamber
- Easier maintenance thanks to back pullout design, enabling service without disturbing motor or casing connections

## SPECIFICATIONS

Flows to: 2000 m<sup>3</sup>/h (8800 gpm)  
 Heads to: 350 m (1100 ft)  
 Press. to: 80 bar (1160 psi)  
 Temp: -160°C to 450°C  
 (-250°F to 842°F)

Refer to literature PS-10-5  
 at [flowserve.com/library](http://flowserve.com/library).

## API PROCESS

## PHL



Flowserve

Fully compliant with ISO 13709/API 610 (OH2), the PHL's innovative multi-channel diffuser technology allows the hydraulics to be custom-tuned to ensure best efficiency hydraulic fits while maximizing parts interchangeability.

- Broad application flexibility from innovative multi-channel diffuser technology, which supports more than 170 hydraulic configurations and easily accommodates changing operating parameters
- Improved pump efficiency via diffuser tuning, which widens operational flow window and minimizes radial loads at any flow
- Extremely low total cost of ownership thanks to long MTBF, low seal emission, long mechanical seal life, low energy consumption and low NPSH
- Improved plant and personnel safety enabled by low vibration and noise levels

## SPECIFICATIONS

Flows to: 900 m<sup>3</sup>/h (3963 gpm)  
 Heads to: 400 m (1312 ft)  
 Press. to: 40 bar (600 psi)  
 Temp: to 450°C (842°F)

Refer to literature PSS-10-5.2  
 at [flowserve.com/library](http://flowserve.com/library).

# OVERHUNG

## API PROCESS

### ERPNI

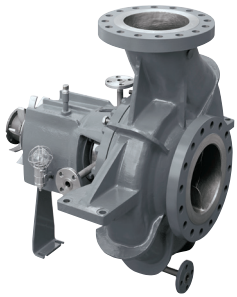

Worthington

The pump of choice for severe chemical, petrochemical, refining and heavy-duty industrial service, closely following ISO 13709/API 610 (OH2), latest edition requirements.

- Greater service life enabled by centerline-supported pump casing that accommodates nozzle loads in accordance with ISO 13709/API 610 requirements, minimizing shaft misalignment and extending rotor, bearing and seal life
- Emissions containment with ISO 21049/API 682 seal chamber, which accepts all seal types, including dual-pressurized and unpressurized cartridge units
- Simplified maintenance and inspection made possible by back pullout design
- Mechanical and hydraulic design flexibility supported by a variety of configurations

#### SPECIFICATIONS

Flows to: 1100 m<sup>3</sup>/h (4800 gpm)  
Heads to: 230 m (755 ft)  
Press. to: 60 bar (870 psi)  
Temp: -50°C to 350°C  
(-158°F to 660°F)

Refer to literature PS-10-20 at [flowserve.com/library](http://flowserve.com/library).

## API PROCESS

### PVXM



Flowserve

Compliant with ISO 13709/API 610 (OH3), the PVXM vertical in-line pump is a space-saving alternative to horizontal overhung process pumps in upstream and downstream services.

- Extra-low energy consumption resulting from precision-machined and interchangeable diffuser channels, which are customized to the hydraulic best efficiency point
- Greater durability from robust design that meets pressure, temperature, nozzle loading and safety considerations of ISO 13709/API 610 and other specifications
- High uptime enabled by stiff rotor design, guaranteeing 20% lower vibration levels than required by ISO 13709/API 610
- Emissions containment with ISO 21049/API 682 seal chamber, which accepts dual-pressurized and unpressurized cartridge seals plus barrier seal technology

#### SPECIFICATIONS

Flows to: 500 m<sup>3</sup>/h (2200 gpm)  
Heads to: 275 m (900 ft)  
Press. to: 40 bar (600 psi)  
Temp: -100°C to 250°C  
(-148°F to 480°F)

Refer to literature PS-10-29 at [flowserve.com/library](http://flowserve.com/library).

## API PROCESS

### HWMA



IDP

With its small footprint, this low-flow, high-head process pump is a space-saving alternative to many overhung process pumps. Compliant with ISO 13709/API 610 (OH3), latest edition. Two-stage configuration HWMA2 available.

- Lower total cost of ownership from optimized hydraulic performance, reduced power consumption and low-flow stability
- Broad application versatility and low energy costs enabled by modular design that offers more than 80 best efficiency point fits in a single pump size
- Precise, repeatable hydraulic performance delivered by replaceable volute insert and Barske-type impeller that provides a continuously rising performance curve with exceptional low-flow stability
- Easy maintenance with large openings on the heavy-duty motor support head

#### SPECIFICATIONS

Flows to: 45 m<sup>3</sup>/h (200 gpm)  
Heads to: 440 m (1445 ft)  
Press. to: 64 bar (930 psi)  
Temp: -46°C to 260°C  
(-51°F to 500°F)

Refer to literature PS-10-23 at [flowserve.com/library](http://flowserve.com/library).



Flowserve

## API PROCESS

## PVML

Compliant with ISO 13709/API 610 (OH5) and BS 4082R, the PVML vertical in-line pump is ideal for upstream and downstream applications where precision hydraulics are required but floor space is limited.

- Lower total cost of ownership from customized hydraulics that generate low vibration levels, high efficiencies and near-zero seal emissions
- Performance flexibility provided by milled and interchangeable diffuser channels, which are customized for specific duty points, enabling customers to address changing operating parameters
- Ease of maintenance enabled by direct-drive design, which does not require alignment, and cartridge seal mounting, which assures precise seal face setting

## SPECIFICATIONS

Flows to: 500 m<sup>3</sup>/h (2220 gpm)  
 Heads to: 275 m (900 ft)  
 Press. to: 40 bar (580 psi)  
 Temp: -100°C to 250°C  
 (-148°F to 480°F)

Refer to literature PS-10-28  
 at [flowserve.com/library](http://flowserve.com/library).



Flowserve

## API PROCESS

## MSP

Closely following ISO 13709/API 610 (OH4) and featuring a medium-speed induction motor, the MSP delivers peak efficiency, excellent economy, simplified installation and reduced maintenance in low-flow, high-head applications.

- Reduced energy costs achieved with variable frequency drive that delivers consistent BEP performance over a wide operating range, without throttling
- Efficient low specific speed hydraulics for low flows at high heads provided by modified concentric volute and impeller with balance holes
- Fast maintenance with rigid coupling design that provides precision shaft alignment while eliminating time-consuming manual alignment
- Easy pump installation and mechanical seal access facilitated by vertical in-line design

## SPECIFICATIONS

Flows to: 34 m<sup>3</sup>/h (150 gpm)  
 Heads to: 900 m (2955 ft)  
 Press. to: 64 bar (930 psi)  
 Temp: -46°C to 250°C  
 (-51°F to 482°F)

Refer to literature PS-10-1  
 at [flowserve.com/library](http://flowserve.com/library).

## API PROCESS

## HWX

Fully compliant with API 610 (OH3), this vertical, in-line pump offers a space-saving alternative for many overhung process pumps in low-temperature, high-temperature and high working pressure services.

- Robust construction to meet pressure, temperature, nozzle loading and safety considerations of ISO 13709/API 610 and other specifications
- Extensive hydraulic coverage by a family of 11 distinct designs, providing a comprehensive range of pump configurations to meet application requirements
- Stringent emissions containment with ISO 21049/API 682 seal chamber, which accommodates dual-pressurized and unpressurized cartridge seals

## SPECIFICATIONS

Flows to: 1300 m<sup>3</sup>/h (5725 gpm)  
 Heads to: 370 m (1215 ft)  
 Press. to: 42 bar (610 psi)  
 Temp: -46°C to 400°C  
 (-51°F to 750°F)

Refer to literature PS-10-27  
 at [flowserve.com/library](http://flowserve.com/library).



Flowserve

# OVERHUNG

## API PROCESS

### HPX6000 and HPXM6000

HPX6000 and HPXM6000 (low-flow) are fully lined slurry pumps built to ISO 13709/API 610 (OH2) and used in heavy oil processing. They reliably handle hot, abrasive solids without the danger of pump casing erosion.



Lawrence Pumps

- Low life cycle cost provided by replaceable mechanically fastened liners that protect the pressure casing from erosion and abrasion
- Process flexibility made possible by interchangeable diffuser, casing liner and impeller, which allow operators to adapt performance to changing process conditions
- Extended operating life ensured by a rigid, oversized bearing frame that maintains shaft deflection below ISO/API requirements
- Casing liners are available in multiple abrasion-resistant materials and surface treatments to meet any process or operational requirement

#### SPECIFICATIONS

Flows to: 3409 m<sup>3</sup>/h (15 000 gpm)  
Heads to: 244 m (800 ft)  
Press. to: 83 bar (1200 psi)  
Temp: -20°C to 400°C  
(-30°F to 826°F)

Refer to literature PS-10-33  
at [flowserve.com/library](http://flowserve.com/library).

## AXIAL FLOW

### AFH9000

Axial flow elbow pump ideal for low-pressure, high-volume transfer applications, such as those frequently found in chemical and hydrocarbon processing. Typical applications include evaporators, crystallizers and heat recovery.



Lawrence Pumps

- Reduced downtime derived from use of large-diameter cantilevered shafts that eliminate need for internal support bearings and minimize deflection at seal chamber
- Ease of maintenance enabled by back pullout design, which simplifies inspection and maintenance of the rotor without disturbing piping or motor connections
- Increased uptime derived from one-piece, 360° bearing frame with deep metal-to-metal fit that provides superior alignment compared to 180° designs

#### SPECIFICATIONS

Flows to: 34 065 m<sup>3</sup>/h (150 000 gpm)  
Heads to: 11 m (36 ft)  
Press. to: 10.3 bar (150 psi)  
Temp: -20°C to 149°C  
(-30°F to 300°F)

Refer to literature PS-100-17  
at [flowserve.com/library](http://flowserve.com/library).





WIKO

## BETWEEN BEARINGS

Long life and high efficiency performance in the world's most critical services characterize this highly engineered range of pumps. Capable of reaching massive flow rates and pressures, single- and double-case designs are designed for continuous operation, often un-spared. Extended uptime is achieved through rugged rotor designs that carefully account for mechanical and hydraulic balance. Energy savings realized from a huge range of hydraulic options keep operating costs in check.

### Between Bearings – Quick Reference\*

Product	Sub-Type	Flows to	Heads to	Pressures to	Temperatures
<b>LR</b>	Single-Case – Axially Split	2000 m <sup>3</sup> /h (8800 gpm)	170 m (560 ft)	21 bar (300 psi)	-20°C to 150°C (-4°F to 300°F)
<b>LNN</b>	Single-Case – Axially Split	30 000 m <sup>3</sup> /h (132 000 gpm)	300 m (985 ft)	40 bar (580 psi)	-20°C to 140°C (-4°F to 285°F)
<b>DVSH</b>	Single-Case – Axially Split – API	12 000 m <sup>3</sup> /h (52 835 gpm)	565 m (1854 ft)	150 bar (2175 psi)	to 200°C (400°F)
<b>LPN</b>	Single-Case – Axially Split – API	15 000 m <sup>3</sup> /h (65 000 gpm)	250 m (820 ft)	50 bar (725 psi)	-80°C to 204°C (-110°F to 400°F)
<b>UZDL</b>	Single-Case – Axially Split – API	2950 m <sup>3</sup> /h (13 000 gpm)	685 m (2250 ft)	64 bar (910 psi)	to 200°C (400°F)
<b>EC</b>	Single-Case – Axially Split – Multistage	2340 m <sup>3</sup> /h (10 300 gpm)	650 m (2130 ft)	88 bar (1300 psi)	-30°C to 150°C (-20°F to 300°F)

\* Additional products shown on next two pages

## Between Bearings – Quick Reference, cont'd.

Product	Sub-Type	Flows to	Heads to	Pressures to	Temperatures
<b>DMX</b>	Single-Case – Axially Split – Multistage	5621 m <sup>3</sup> /h (24 750 gpm)	2620 m (8600 ft)	275 bar (4000 psi)	to 204°C (400°F)
<b>HDX</b>	Single-Case – Radially Split	5000 m <sup>3</sup> /h (22 000 gpm)	450 m (1500 ft)	100 bar (1450 psi)	to 450°C (842°F)
<b>DVSR</b>	Single-Case – Radially Split	6585 m <sup>3</sup> /h (29 000 gpm)	330 m (1080 ft)	260 bar (3750 psi)	to 204°C (400°F)
<b>HED and HED-DS</b>	Single-Case – Radially Split	2000 m <sup>3</sup> /h (8800 gpm)	450 m (1500 ft)	100 bar (1450 psi)	to 450°C (842°F)
<b>WTB</b>	Single-Case – Radially Split	1400 m <sup>3</sup> /h (6165 gpm)	1100 m (3610 ft)	108 bar (1565 psi)	to 430°C (800°F)
<b>HEGA</b>	Horizontal – Multistage Single-Case	145 m <sup>3</sup> /h (638 gpm)	390 m (1279 ft)	40 bar (580 psi)	to 194°C (380°F)
<b>UEA</b>	Horizontal – Multistage Single-Case	220 m <sup>3</sup> /h (969 gpm)	280 m (918 ft)	20 bar (290 psi)	to 140°C (284°F)
<b>TKH</b>	Horizontal – Multistage Single-Case	350 m <sup>3</sup> /h (1541 gpm)	185 m (607 ft)	16 bar (232 psi)	to 120°C (248°F)
<b>WD and WDX</b>	Horizontal – Multistage Single-Case	190 m <sup>3</sup> /h (800 gpm)	700 m (2625 ft)	75 bar (1090 psi)	to 210°C (410°F)
<b>WX</b>	Horizontal – Multistage Single-Case	300 m <sup>3</sup> /h (1320 gpm)	1200 m (3940 ft)	150 bar (2175 psi)	-50°C to 200°C (-58°F to 400°F)
<b>CSX</b>	Horizontal – Multistage Single-Case	1200 m <sup>3</sup> /h (5300 gpm)	900 m (2950 ft)	100 bar (1450 psi)	—
<b>WXH and WXM</b>	Horizontal – Multistage Single-Case	1000 m <sup>3</sup> /h (4500 gpm)	2750 m (9000 ft)	310 bar (4500 psi)	to 250°C (480°F)
<b>MSL, MSM, MSC, MSH</b>	Horizontal – Multistage Single-Case	450 m <sup>3</sup> /h (1981 gpm)	1600 m (5249 ft)	160 bar (2320 psi)	-10°C to 180°C (14°F to 356°F)
<b>NM</b>	Horizontal – Multistage Single-Case	3000 m <sup>3</sup> /h (13 210 gpm)	500 m (1640 ft)	60 bar (870 psi)	-10°C to 140°C (14°F to 285°F)



Product	Sub-Type	Flows to	Heads to	Pressures to	Temperatures
<b>WXB and WXB-B</b>	Horizontal – Multistage Double-Case	300 m <sup>3</sup> /h (1320 gpm)	1560 m (5116 ft)	200 bar (2900 psi)	to 425°C (800°F)
<b>CSB</b>	Horizontal – Multistage Double-Case	1000 m <sup>3</sup> /h (4500 gpm)	3650 m (12 000 ft)	427 bar (6190 psi)	to 250°C (480°F)
<b>CHTA</b>	Horizontal – Multistage Double-Case	3900 m <sup>3</sup> /h (17 170 gpm)	4500 m (14 750 ft)	538 bar (7800 psi)	to 250°C (480°F)
<b>HDB and HSB</b>	Horizontal – Multistage Double-Case	4000 m <sup>3</sup> /h (17 610 gpm)	4300 m (14 000 ft)	450 bar (6525 psi)	to 425°C (800°F)
<b>BP</b>	Horizontal – Multistage Double-Case	1050 m <sup>3</sup> /h (4620 gpm)	3500 m (11 480 ft)	295 bar (4260 psi)	to 425°C (800°F)
<b>WCC</b>	Horizontal – Multistage Double-Case	1000 m <sup>3</sup> /h (4400 gpm)	2800 m (9200 ft)	275 bar (4000 psi)	to 425°C (800°F)
<b>HDO and HSO</b>	Horizontal – Multistage Double-Case	4000 m <sup>3</sup> /h (17 610 gpm)	5365 m (16 000 ft)	450 bar (6525 psi)	to 425°C (800°F)
<b>WIK and WIKO</b>	Horizontal – Multistage Double-Case	1600 m <sup>3</sup> /h (7000 gpm)	7000 m (23 000 ft)	1000 bar (14 500 psi)	to 425°C (800°F)

# BETWEEN BEARINGS

## SINGLE-CASE – AXIALLY SPLIT

### LR

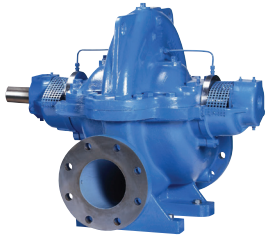

Worthington

Heavy-duty, single-stage pump engineered to provide reliable, efficient performance in a wide range of applications across numerous industries. Two-stage (LLR) and vertical in-line (LRV) configurations available.

- High efficiency and optimum performance over a wide flow range due to low-NPSH enclosed impeller and casing wear rings that easily restore operating clearances
- Application versatility provided by numerous options that permit the pump to be precisely configured for service requirements
- Low inventory carrying costs made possible by parts interchangeability among sizes and configurations
- Ease of maintenance resulting from axial split-case design, which allows access to rotating element without disturbing the piping or driver

#### SPECIFICATIONS

Flows to: 2000 m<sup>3</sup>/h (8800 gpm)  
Heads to: 170 m (560 ft)  
Press. to: 21 bar (300 psi)  
Temp: -20°C to 150°C (-4°F to 300°F)

Refer to literature PS-20-3  
at [flowserve.com/library](http://flowserve.com/library).

## SINGLE-CASE – AXIALLY SPLIT

### LNN



Worthington

The LNN boasts a broad hydraulic range with more than 200 impeller and volute combinations, resulting in quiet operation, low NPSH requirements, and high efficiency operation in all water applications.

- Optimal hydraulic balance and efficiency over its full operating range provided by double suction impeller operating in a double volute, axially split casing
- Low inventory carrying cost provided by a high degree of parts interchangeability among sizes and configurations
- Application flexibility enabled by ability to modify pump performance to meet future service conditions by changing impeller designs
- Increased uptime from double-volute design, ample shaft and 360° bearing housings, all of which minimize shaft deflection and vibration to extend bearing and seal life

#### SPECIFICATIONS

Flows to: 30 000 m<sup>3</sup>/h (132 000 gpm)  
Heads to: 300 m (985 ft)  
Press. to: 40 bar (580 psi)  
Temp: -20°C to 140°C (-4°F to 285°F)

Refer to literature PS-20-1  
at [flowserve.com/library](http://flowserve.com/library).

## SINGLE-CASE – AXIALLY SPLIT – API

### DVSH

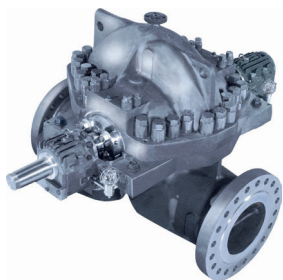

Flowserve

Fully compliant with ISO 13709/API 610 (BB1), this heavy-duty, single-stage pump with side/side nozzles is well-suited for process charge, transfer and pipeline services where uncompromising reliability over a wide flow range is paramount.

- Low operating costs derived from comprehensive hydraulic coverage (more than 100 sizes), thereby permitting precise selection for best hydraulic fit and efficiency
- High uptime made possible by double suction impeller and double volute designs, which create optimal axial and radial thrust balance
- Increased reliability provided by the heavy-duty shaft design, which ensures trouble-free operation below the first critical speed
- Ease of maintenance due to suction and discharge nozzles that are integrally cast in lower casing half, permitting disassembly without disturbing piping

#### SPECIFICATIONS

Flows to: 12 000 m<sup>3</sup>/h (52 835 gpm)  
Heads to: 565 m (1854 ft)  
Press. to: 150 bar (2175 psi)  
Temp: to 200°C (400°F)

Refer to literature PS-20-2  
at [flowserve.com/library](http://flowserve.com/library).

## SINGLE-CASE – AXIALLY SPLIT – API

## LPN



Worthington

With a double suction impeller and side-side nozzles, this medium-pressure pump is a natural solution for low NPSH applications, such as water and hydrocarbon transfer service. Designed to ISO 13709/API 610 (BB1) criteria.

- High uptime made possible by double-suction impeller and double volute designs, which create optimal axial and radial thrust balance
- Increased MTBR resulting from heavy-duty bearings and bearing lubrication system; multiple options available to suit application requirements
- Superior performance at elevated temperatures with near-centerline mounting
- Simplified maintenance enabled by the split-casing design, which permits the rotor, seals and bearings to be serviced without disturbing the piping
- Emissions control with ISO 21049/API 682 seal chambers

## SPECIFICATIONS

Flows to: 15 000 m<sup>3</sup>/h (65 000 gpm)  
Heads to: 250 m (820 ft)  
Press. to: 50 bar (725 psi)  
Temp: -80°C to 204°C  
(-110°F to 400°F)

Refer to literature PS-20-5  
at [flowserve.com/library](http://flowserve.com/library).

## SINGLE-CASE – AXIALLY SPLIT – API

## UZDL



Worthington

A two-stage pump with a double suction, first-stage impeller, the UZDL is designed for water pipelines, transfer services, firefighting and high-pressure duties. ISO 13709/API 610 (BB1) compliant models available.

- Increased uptime made possible by double volute design that minimizes hydraulic radial loads, and virtually eliminates shaft deflection and vibration
- Safety and environmental compliance with ISO 21049/API 682 seal chambers
- Increased reliability provided by stiff shaft design, which ensures trouble-free operation below the first critical speed
- Ease of maintenance due to suction and discharge nozzles that are integrally cast in lower casing half, permitting disassembly without disturbing piping

## SPECIFICATIONS

Flows to: 2950 m<sup>3</sup>/h (13 000 gpm)  
Heads to: 685 m (2250 ft)  
Press. to: 64 bar (910 psi)  
Temp: to 200°C (400°F)

Refer to literature PS-30-2  
at [flowserve.com/library](http://flowserve.com/library).

## Partnerships With Long-Term Value

Flowserve enterprise framework agreement (EFA) partners have access to all facets of our business, from front-end engineering to research and development to solve real-world problems. It's a total lifecycle management approach that applies to day-to-day operational challenges as well as plant expansions and greenfield projects — and it pays. One EFA partner has garnered more than \$400 million in value in the first five years.



# BETWEEN BEARINGS

## SINGLE-CASE – AXIALLY SPLIT – MULTISTAGE

### EC

This multistage, horizontal split-case pump is designed to support large flow and high head applications in mining and water transmission.



TKL

- Lower maintenance time and costs enabled by horizontally split casing and removable pump rotor, which allow access without disturbing suction and discharge connections or motor alignment
- Installation ease via pump design that can be mounted horizontally or vertically
- Longer service life from shaft sleeves that reduce friction wear and graphite-impregnated packing, which provides easy leakage adjustment

#### SPECIFICATIONS

Flows to: 2340 m<sup>3</sup>/h (10 300 gpm)  
Heads to: 650 m (2130 ft)  
Press. to: 88 bar (1300 psi)  
Temp: -30°C to 150°C  
(-20°F to 300°F)

## SINGLE-CASE – AXIALLY SPLIT – MULTISTAGE

### DMX

With more than 10 000 units supplied, this highly reliable pump is ideal for high-flow, high-pressure applications across the gamut of industries, including oil and gas, chemical and desalination. Designed to ISO 13709/API 610 (BB3) criteria.



Flowserve

- Increased uptime enabled by opposed mounted impellers operating in a double volute casing, which provide inherent hydraulic balance over the full operating range
- Broad application versatility provided by numerous options that permit the pump to be precisely configured for service requirements
- Superior performance at elevated temperatures with near-centerline mounting
- Ease of maintenance facilitated by cap nuts on top half casing parting flange
- Emissions control with ISO 21049/API 682 seal chambers

#### SPECIFICATIONS

Flows to: 5621 m<sup>3</sup>/h (24 750 gpm)  
Heads to: 2620 m (8600 ft)  
Press. to: 275 bar (4000 psi)  
Temp: to 204°C (400°F)

Refer to literature PS-30-3  
at [flowserve.com/library](http://flowserve.com/library).

## SINGLE-CASE – RADIALY SPLIT

### HDX

In full compliance with ISO 13709/API 610 (BB2) standards, the HDX centerline mounted pump with single-stage, double-suction impeller and double volute casing with top nozzles is engineered for heavy process services.



IDP

- Increased uptime enabled by double suction impeller that minimizes thrust problems, reduces NPSHR, and allows mechanical seals to operate at equal and low pressure
- Excellent high-temperature performance provided by centerline mounting plus gasketing with metal-to-metal fit to ensure proper sealing and alignment
- Installation ease with top-top, side-top and side-side nozzle configurations available to meet any customer piping layout
- Safety and environmental compliance with ISO 21049/API 682 seal chambers
- Power recovery turbine configuration (HDX-TT) available

#### SPECIFICATIONS

Flows to: 5000 m<sup>3</sup>/h (22 000 gpm)  
Heads to: 450 m (1500 ft)  
Press. to: 100 bar (1450 psi)  
Temp: to 450°C (842°F)

Refer to literature PS-20-4  
at [flowserve.com/library](http://flowserve.com/library).

## SINGLE-CASE – RADIALLY SPLIT

## DVSR



Byron Jackson

Compliant with ISO 13709/API 610 (BB2), the radially split design of the DVSR makes it ideal for applications at very high pressures or low specific gravity, such as liquefied gases, including CO<sub>2</sub>.

- Maximum efficiency through a double-suction impeller that provides axial hydraulic thrust balance
- Higher uptime due to a double-volute design that minimizes hydraulic loads, even at minimal flow, to prolong the life of bearings, seals and wear rings
- Stringent emissions control with ISO 21049/API 682 seal chambers
- Trouble-free operation below the first critical speed ensured by the heavy-duty shaft design
- API performance testing is conducted on each pump prior to shipment

## SPECIFICATIONS

Flows to: 6585 m<sup>3</sup>/h (29 000 gpm)  
Heads to: 330 m (1080 ft)  
Press. to: 260 bar (3750 psi)  
Temp: to 204°C (400°F)

Refer to literature PS-30-17  
at [flowserve.com/library](http://flowserve.com/library).

## SINGLE-CASE – RADIALLY SPLIT

## HED and HED-DS

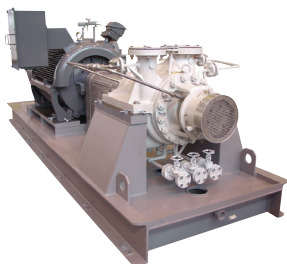

Pacific

Two-stage, centerline mounted pump engineered for safe, reliable operation in heavy-duty process services and elevated temperatures. Fully compliant with ISO 13709/API 610 (BB2).

- Extended reliability and life made possible by heavy-duty, single- or dual-volute casings with a staggered arrangement, which ensures radial balance
- Application versatility provided by numerous options — including 50- or 60-cycle operation and top-top, side-top and side-side nozzle orientations — that permit the pump to be precisely configured for service and site requirements
- Increased reliability provided by stiff shaft design, which ensures trouble-free operation below the first critical speed
- Environmental regulatory compliance with ISO 21049/API 682 seal chambers

## SPECIFICATIONS

Flows to: 2000 m<sup>3</sup>/h (8800 gpm)  
Heads to: 650 m (2100 ft)  
Press. to: 120 bar (1750 psi)  
Temp: to 450°C (842°F)

Refer to literature PS-30-4  
at [flowserve.com/library](http://flowserve.com/library).

## SINGLE-CASE – RADIALLY SPLIT

## WTB



Worthington

With hydraulics between typical BB2 and BB5 pumps, the WTB is a reliable solution for niche high-temperature and high-pressure applications in refineries, chemical operations and power plants. Made in two- and three-stage designs.

- Reliable operation ensured by compliance with all key ISO 13709/API 610 requirements (two-stage unit is fully compliant)
- Stable performance with radial hydraulic balance over the pump's full operating range ensured by heavy-duty, dual-volute casing with integral crossover
- Excellent high-temperature and pressure performance enabled by centerline-supported, radially split design that prevents distortion
- Reduced operating costs provided by the double-suction, first-stage impeller, which significantly reduces NPSHR, often eliminating the need for booster units

## SPECIFICATIONS

Flows to: 1400 m<sup>3</sup>/h (6165 gpm)  
Heads to: 1100 m (3610 ft)  
Press. to: 108 bar (1565 psi)  
Temp: to 430°C (800°F)

# BETWEEN BEARINGS

## HORIZONTAL – MULTISTAGE – SINGLE-CASE

### HEGA

Cost-effective ring-section pumps with closed impellers, designed for power, water and wastewater, pharmaceutical and chemical applications requiring trouble-free pumping of clear or slightly dirty liquids.



SIHI

- Reduced energy costs achieved by sizing impellers for best hydraulic fit and operating efficiency
- Low installation costs enabled by movable suction head casing, which easily adapts flange position to site conditions
- Low inventory carrying costs enabled by high degree of parts interchangeability
- Reliable bearing performance provided by grease lubricated deep groove and cylindrical roller bearing, respectively meeting DIN 625 and DIN 5412
- Shaft sealing by a stuffing box or mechanical seal to suit application requirements

#### SPECIFICATIONS

Flows to: 145 m<sup>3</sup>/h (638 gpm)  
Heads to: 390 m (1279 ft)  
Press. to: 40 bar (580 psi)  
Temp: to 194°C (380°F)

## HORIZONTAL – MULTISTAGE – SINGLE-CASE

### UEA

Horizontal, self-priming multistage ring-section pump designed for pumping liquids at their boiling point. It is particularly well suited for condensates, liquefied gases, refrigerants, LPG and boiler feedwater.

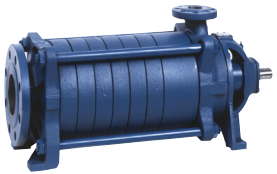

SIHI

- Safe, reliable pumping of boiling liquids ensured by a special priming stage that absorbs vapor from the suction side
- Trouble-free operation under unfavorable suction conditions enabled by axial inlet with NPSH inducer stage
- Wide application range resulting from its ability to handle liquids at their boiling points as well as its low required NPSH
- Shaft sealing by a single- or double-mechanical seal to suit application requirements

#### SPECIFICATIONS

Flows to: 220 m<sup>3</sup>/h (969 gpm)  
Heads to: 280 m (918 ft)  
Press. to: 20 bar (290 psi)  
Temp: to 140°C (284°F)

Refer to literature PS-120-2  
at [flowserve.com/library](http://flowserve.com/library).

## HORIZONTAL – MULTISTAGE – SINGLE-CASE

### TKH

Horizontal, self-priming and segmental-type centrifugal pumps with shrouded impellers for water and utility water supply, fuel handling, and chemical and petrochemical applications.



SIHI

- Reduced downtime resulting from the separation of gas before entering the first impeller
- Maximum performance via a priming stage that runs in parallel with the first liquid stage and operates according to the mixed media separation principle
- Wide range of applications due to the self-priming capability and multitude of material combinations, including shipbuilding and the construction of cooling and firefighting equipment

#### SPECIFICATIONS

Flows to: 350 m<sup>3</sup>/h (1541 gpm)  
Heads to: 185 m (607 ft)  
Press. to: 16 bar (232 psi)  
Temp: to 120°C (248°F)

## HORIZONTAL – MULTISTAGE – SINGLE-CASE

## WD and WDX

These radially split, high-pressure, multistage, ring section pumps are designed for a wide range of process and industrial applications.

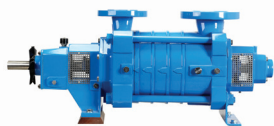

IDP

- Optimized performance without loss of head or risk of cavitation due to low NPSHR suction impeller and fully machined diffusers
- Reliable operation at a range of duty points due to suction, discharge and stage casings that are sealed with O-rings and engineered to contain the pressures generated by the pump at the various design pressures and temperatures
- Broad application flexibility enabled by modular construction, featuring identical stages stacked axially to achieve the desired pressure output

## SPECIFICATIONS

Flows to: 190 m<sup>3</sup>/h (800 gpm)  
Heads to: 700 m (2625 ft)  
Press. to: 75 bar (1090 psi)  
Temp: to 210°C (410°F)

## HORIZONTAL – MULTISTAGE – SINGLE-CASE

## WX

A radially split, centerline mounted ring section pump, the WX is available in various API 610 material combinations to suit application needs. It provides reliable, efficient performance with total lifecycle cost economy.

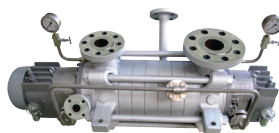

Worthington

- Greater hydraulic performance made possible by separate cast diffusers and channel rings, investment cast for optimum efficiency and repeatability
- Stable high-temperature operation with proper alignment due to centerline mounted, self-venting casing, which resists distortion from thermal expansion
- Improved efficiency at all operating conditions from balanced axial thrust loads enabled by a unique balance drum

## SPECIFICATIONS

Flows to: 300 m<sup>3</sup>/h (1320 gpm)  
Heads to: 1200 m (3940 ft)  
Press. to: 150 bar (2175 psi)  
Temp: -50°C to 200°C (-58°F to 400°F)

## HORIZONTAL – MULTISTAGE – SINGLE-CASE

## CSX

The CSX represents the next generation of segmental ring, diffuser-style pumps. Particularly well-suited for reverse osmosis desalination systems, it provides long-term, high-efficiency operation with low lifecycle costs.



IDP

- Low energy consumption ensured by advanced hydraulic, precision-cast diffusers and channel rings, high-efficiency impellers and renewable case wear rings
- Prolonged operating life made possible by corrosion-resistant materials of construction (including proprietary Alloy 885) for wetted components
- Easy installation due to symmetrical suction and discharge heads that enable the pump nozzles to be rotated and positioned to suit a variety of piping layouts

## SPECIFICATIONS

Flows to: 1200 m<sup>3</sup>/h (5300 gpm)  
Heads to: 900 m (2950 ft)  
Press. to: 100 bar (1450 psi)

Refer to literature PS-30-15 at [flowserve.com/library](http://flowserve.com/library).

# BETWEEN BEARINGS

## HORIZONTAL – MULTISTAGE – SINGLE-CASE

### WXH and WXM



IDP

These high- (WXH) and medium-pressure (WXM), utility-grade, ring section pumps are particularly well-suited for feedwater on industrial boilers from small to large sizes and in combined cycle where severe cycling is common.

- Greater reliability from radially split pressure casings, ensuring overall pump concentricity and rotor alignment
- Improved service life and tolerance to changing conditions due to precision-cast diffusers that equalize radial loads and increase bearing, wear ring and seal life
- Decreased maintenance costs and longer service intervals enabled by heavy-duty rotor with short bearing spans, which minimizes deflection
- Precise hydraulic configuration made possible by the modular segmental ring diffuser design plus numerous options

#### SPECIFICATIONS

Flows to: 1000 m<sup>3</sup>/h (4500 gpm)  
Heads to: 2750 m (9000 ft)  
Press. to: 310 bar (4500 psi)  
Temp: to 250°C (480°F)

Refer to literature PS-30-1 at [flowserve.com/library](http://flowserve.com/library).

## HORIZONTAL – MULTISTAGE – SINGLE-CASE

### MSL, MSM, MSC and MSH



SIHI

Next-generation, multistage, ring section pumps designed to provide the highest efficiency, long-term reliability and easy operation. Meet the technical requirements of ISO 5199/EN 25199.

- Broad application flexibility facilitated by advanced modular design that allows different hydraulic impeller and diffuser sizes to be installed in a standardized casing, enabling the pump to be configured for the exact working point required
- Low inventory carrying costs made possible by a design that maximizes interchangeability while reducing the total number of parts needed
- Ease of installation via discharge casing flange, which can be supplied radially upward, horizontal-left or horizontal-right to suit site conditions

#### SPECIFICATIONS

Flows to: 450 m<sup>3</sup>/h (1981 gpm)  
Heads to: 1600 m (5249 ft)  
Press. to: 160 bar (2320 psi)  
Temp: -10°C to 180°C (14°F to 356°F)

Refer to literature PS-30-22 at [flowserve.com/library](http://flowserve.com/library).

## HORIZONTAL – MULTISTAGE – SINGLE-CASE

### NM



IDP

The NM radially split, multistage, ring section pump is designed for a wide range of applications in the water, power and general industries.

- Reliable performance from low NPSH suction volute design
- Increased efficiency made possible by machined impeller shrouds
- Greater bearing and seal life due to stable operation from impeller balance holes (minimizing axial thrust) and shrouded diffusers with return guide vanes (minimizing radial thrust)
- Broad application versatility enabled by flexible design, suitable for cooling water (power), fire protection, flood control, boiler feed, water supply and distribution (water), agriculture, ground water development and irrigation

#### SPECIFICATIONS

Flows to: 3000 m<sup>3</sup>/h (13 210 gpm)  
Heads to: 500 m (1640 ft)  
Press. to: 60 bar (870 psi)  
Temp: -10°C to 140°C (14°F to 285°F)



## The Business of Asset Performance

Flowserve is committed to helping customers realize more payback from their operations. Our reliability and performance engineers can help implement a range of asset management and optimization solutions — asset performance, equipment optimization, performance trend analysis and physical assessments — aimed at identifying lifecycle cost savings opportunities. The result is a self-financing road map to improved operational performance.



### HORIZONTAL – MULTISTAGE – DOUBLE-CASE

## WXB and WXB-B

Based on ISO 13709/API 610 design requirements, this diffuser-casing barrel pump is the first choice for demanding applications in refineries, chemical and petrochemical plants, liquefied gas stations and boiler feed service.



Worthington

- Space-saving design with minimal maintenance downtime due to compact and convenient cartridge-style construction
- Longer service life via a generous shaft diameter that results in low shaft deflection to increase bearing, mechanical seal and wear ring life
- Lower maintenance costs resulting from renewable wear rings on all casings and impellers to permit economical restoration of running clearances
- Emissions control with ISO 21049/API 682 seal chambers
- Low-flow, high head stability with Barske-style impeller (WXB-B)

#### SPECIFICATIONS

Flows to: 300 m<sup>3</sup>/h (1320 gpm)  
Heads to: 1560 m (5116 ft)  
Press. to: 200 bar (2900 psi)  
Temp: to 425°C (800°F)

Refer to literature PS-30-6 and PSS-30-6.1 at [flowserve.com/library](http://flowserve.com/library).

### HORIZONTAL – MULTISTAGE – DOUBLE-CASE

## CSB

Cost-effective, diffuser-style barrel pump for boiler feed service in combined cycle and conventional steam plants. Built to ASME Section VIII, it delivers exceptionally smooth pumping in a compact, space-saving design.

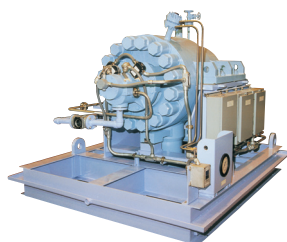

IDP

- Energy efficiency and operation stability provided by a continuous crossover diffuser that precisely converts velocity to pressure
- Ease of maintenance resulting from a radially split, inner case sub-assembly that facilitates inspection and maintenance in the field
- Longer service life due to a high shaft diameter-to-bearing span ratio that results in low shaft deflection to increase bearing, mechanical seal and wear ring life
- Durability via forged barrel made from homogeneous, high-strength chromium steel for high-pressure performance and erosion-corrosion resistance

#### SPECIFICATIONS

Flows to: 1000 m<sup>3</sup>/h (4500 gpm)  
Heads to: 3650 m (12 000 ft)  
Press. to: 427 bar (6190 psi)  
Temp: to 250°C (480°F)

Refer to literature PS-30-12 at [flowserve.com/library](http://flowserve.com/library).

# BETWEEN BEARINGS

## HORIZONTAL – MULTISTAGE – DOUBLE-CASE

### CHTA



*IDP*

Exceptionally reliable utility grade barrel pump for the most demanding high-energy applications. Built to ASME Section VIII, it is often applied unspared in supercritical power plants and extended service run applications.

- Smooth, reliable operation due to precision cast diffusers that are fully shrouded and 100% NDE inspected
- Longer service life via rugged rotor with in-line impellers, minimized bearing spans and heavy-duty shaft to reduce the effect of rotor contact during upsets
- Improved durability of critical clearance parts with advanced laser treatments that reduce wear
- Upset tolerance provided by a compensator gasket group that allows for expansion during thermal transients while also maintaining seal integrity

#### SPECIFICATIONS

Flows to: 3900 m<sup>3</sup>/h (17 170 gpm)  
Heads to: 4500 m (14 750 ft)  
Press. to: 538 bar (7800 psi)  
Temp: to 250°C (480°F)

Refer to literature PS-30-13  
at [flowserve.com/library](http://flowserve.com/library).

## HORIZONTAL – MULTISTAGE – DOUBLE-CASE

### HDB and HSB

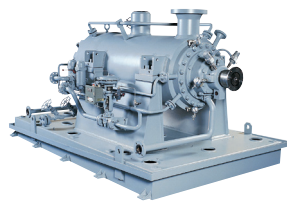

*Byron Jackson*

Dual volute-type barrel pumps with axially split inner cases, the HDB and HSB are renowned for high reliability and uptime in various applications in the power generation industry.

- Operational stability and reliability are inherent to the rugged dual-volute and opposed-impeller design plus forged barrel, utility grade rotor and heavy-duty bearings
- Easy maintenance facilitated by the precision-machined axially split inner case, which requires only light bolting because it is under hydraulic compression
- Low NPSHA and excellent flow stability with an available double-suction, first-stage impeller (HDB)
- Excellent rotor dynamics due to the dynamically balanced rotor, ensuring inherently balanced axial thrust over the full operating range

#### SPECIFICATIONS

Flows to: 4000 m<sup>3</sup>/h (17 610 gpm)  
Heads to: 4300 m (14 000 ft)  
Press. to: 450 bar (6525 psi)  
Temp: to 425°C (800°F)

Refer to literature PS-30-12  
at [flowserve.com/library](http://flowserve.com/library).

## HORIZONTAL – MULTISTAGE – DOUBLE-CASE

### BP



*Niigata Worthington*

Medium-pressure, diffuser-style barrel pump for boiler feed, descaling, reactor charge and other services. Compliant with ISO 13709/API 610 (BB5) requirements.

- Optimized efficiency due to precision-cast impellers and diffusers, designed using the latest computational fluid dynamics technology
- Ease of maintenance resulting from a progressively stepped shaft that simplifies replacement of shrink-fit impellers
- Adaptable to the effects of pressure and temperature provided by spiral-wound gaskets, which are also corrosion-resistant
- Superior corrosion-resistance and reliable sealing in high-pressure and high-temperature services due to Inconel coating on critical sealing surfaces

#### SPECIFICATIONS

Flows to: 1050 m<sup>3</sup>/h (4620 gpm)  
Heads to: 3500 m (11 480 ft)  
Press. to: 295 bar (4260 psi)  
Temp: to 425°C (800°F)

Refer to literature PS-30-11  
at [flowserve.com/library](http://flowserve.com/library).

## HORIZONTAL – MULTISTAGE – DOUBLE-CASE

## WCC

Medium-duty, diffuser-type barrel pump built to ISO 13709/API 610 (BB5) and customer specifications. Typically used in refinery services, pipeline, amine and ethylene feed, water and CO<sub>2</sub> injection, plus hydraulic power recovery.

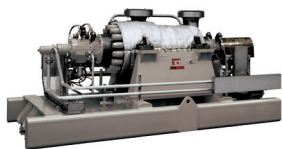

IDP

- Optimized hydraulic efficiency and repeatable performance due to precision-cast tandem impellers, multi-vane diffusers and advanced balance drum design
- Incredible reliability with advanced close clearance technologies, erosion- and abrasion-resistant materials in the running fits, and robust bearing system
- Reduced downtime and maintenance from the standard cartridge type construction that allows major assembly and disassembly in the workshop rather than the field
- Balanced hydraulic loads over the operating range while maximizing efficiency at duty conditions enabled by single diameter balance drum

## SPECIFICATIONS

Flows to: 1000 m<sup>3</sup>/h (4400 gpm)  
Heads to: 2800 m (9200 ft)  
Press. to: 275 bar (4000 psi)  
Temp. to: 425°C (800°F)

Refer to literature PS-30-7  
at [flowserve.com/library](http://flowserve.com/library).

## HORIZONTAL – MULTISTAGE – DOUBLE-CASE

## HDO and HSO

Offered in both general and special purpose configurations, these volute-style barrel pumps are manufactured to customer specifications, often exceeding ISO 13709/API 610 (BB5).



Byron Jackson

- Highest reliability in critical processes assured by the volute design
- Improved hydraulic efficiency and performance repeatability provided by the precision-cast opposed impellers
- Nearly balanced axial thrust with volute-type opposed impeller design that breaks down 50% of the discharge pressure to the intermediate stage before the long crossover
- Excellent rotor dynamics due to the dynamically balanced rotor, ensuring inherently balanced axial thrust over the full operating range

## SPECIFICATIONS

Flows to: 4000 m<sup>3</sup>/h (17 610 gpm)  
Heads to: 5365 m (16 000 ft)  
Press. to: 450 bar (6525 psi)  
Temp. to: 425°C (800°F)

Refer to literature PS-30-8  
at [flowserve.com/library](http://flowserve.com/library).

## HORIZONTAL – MULTISTAGE – DOUBLE-CASE

## WIK and WIKO

Extra heavy-duty barrel pump intended for special purpose, unspared, high-power density applications. Pumps are custom engineered to customer requirements, often exceeding ISO 13709/API 610 (BB5).



Flowserve

- Outstanding reliability assured by low static deflection, the result of a large diameter shaft and short bearing spans
- Optimized efficiency due to precision-cast, low specific speed impellers, multi-vane diffuser and milled channel collectors to ensure repeatable performance
- Smooth, stable performance with multi-vane, split diffuser and channel ring collectors that eliminate radial imbalance
- Performance tested in accordance with API and Hydraulic Institute standards
- Ease of maintenance with back pullout, cartridge-style construction

## SPECIFICATIONS

Flows to: 1600 m<sup>3</sup>/h (7000 gpm)  
Heads to: 7000 m (23 000 ft)  
Press. to: 1000 bar (14 500 psi)  
Temp. to: 425°C (800°F)

Refer to literature PS-30-9  
at [flowserve.com/library](http://flowserve.com/library).



VPC

## VERTICAL

The global requirement for vertical pumps is diverse. The Flowserve portfolio reliably addresses the vast majority, from general industrial products to massive systems used in power generation and oil and gas. Designed to critical global standards, these pumps meet customer energy savings goals with their extensive hydraulic options that precisely meet operating requirements. Long-life performance in aggressive media is achieved with non-metallic and erosion-resistant wet ends for many designs.

### Vertical – Quick Reference\*

Product	Sub-Type	Flows to	Heads to	Pressures to	Temperatures
<b>WUJ</b>	Wet-Pit	3000 m <sup>3</sup> /h (13 200 gpm)	2000 m (6560 ft)	200 bar (2900 psi)	-200°C to 350°C (-328°F to 660°F)
<b>VTP</b>	Wet-Pit	13 600 m <sup>3</sup> /h (60 000 gpm)	700 m (2300 ft)	100 bar (1450 psi)	-73°C to 200°C (-100°F to 400°F)
<b>QL and QLQ</b>	Wet-Pit	25 000 m <sup>3</sup> /h (110 000 gpm)	500 m (1640 ft)	70 bar (1015 psi)	-45°C to 204°C (-50°F to 400°F)
<b>VCT</b>	Wet-Pit	181 700 m <sup>3</sup> /h (800 000 gpm)	110 m (350 ft)	—	—
<b>AFV</b>	Wet-Pit	181 700 m <sup>3</sup> /h (800 000 gpm)	11 m (35 ft)	—	—
<b>Barge VTP</b>	Wet-Pit	1035 m <sup>3</sup> /h (5000 gpm)	120 m (400 ft)	8.6 bar (125 psi)	-18°C to 150°C (0°F to 300°F)
<b>Molten Salt VTP</b>	Wet-Pit	13 600 m <sup>3</sup> /h (60 000 gpm)	530 m (1740 ft)	100 bar (1450 psi)	to 600°C (1100°F)

\* Additional products shown on next page

## Vertical – Quick Reference, cont'd.

Product	Sub-Type	Flows to	Heads to	Pressures to	Temperatures
<b>QLC and QLQC</b>	Double-Case	25 000 m <sup>3</sup> /h (110 000 gpm)	500 m (1640 ft)	70 bar (1015 psi)	-45°C to 204°C (-50°F to 400°F)
<b>VPC</b>	Double-Case	13 600 m <sup>3</sup> /h (60 000 gpm)	1070 m (3500 ft)	100 bar (1450 psi)	-73°C to 230°C (-100°F to 450°F)
<b>WUC</b>	Double-Case	3000 m <sup>3</sup> /h (13 200 gpm)	2000 m (6560 ft)	200 bar (2900 psi)	-200°C to 350°C (-328°F to 660°F)
<b>APKD</b>	Double-Case	4600 m <sup>3</sup> /h (20 200 gpm)	500 m (1640 ft)	50 bar (725 psi)	-18°C to 200°C (0°F to 400°F)
<b>Byron Jackson SUBM - H<sub>2</sub>O</b>	Deep-Well Submersible Motor	6000 m <sup>3</sup> /h (26 415 gpm)	800 m (2625 ft)	—	—
<b>Byron Jackson SUBM - OIL</b>	Deep-Well Submersible Motor	6000 m <sup>3</sup> /h (26 415 gpm)	800 m (2625 ft)	—	—
<b>MJ and MJC</b>	Slurry	1350 m <sup>3</sup> /h (6000 gpm)	30 m (100 ft)	10 bar (150 psi)	to 110°C (225°F)
<b>RJ and RJC</b>	Slurry	1350 m <sup>3</sup> /h (6000 gpm)	30 m (100 ft)	10 bar (150 psi)	to 110°C (225°F)
<b>Terra-Titan</b>	Slurry	250 m <sup>3</sup> /h (1100 gpm)	45 m (150 ft)	5 bar (70 psi)	to 100°C (212°F)
<b>VPL3300</b>	Slurry	4542 m <sup>3</sup> /h (20 000 gpm)	91 m (300 ft)	—	to 593°C (1100°F)
<b>VPL3600</b>	Slurry	1500 m <sup>3</sup> /h (6600 gpm)	150 m (492 ft)	—	to 100°C (212°F)
<b>MVX</b>	Solids Handling	17 000 m <sup>3</sup> /h (75 000 gpm)	40 m (130 ft)	7 bar (100 psi)	to 40°C (104°F)
<b>CPXV</b>	Sump	1400 m <sup>3</sup> /h (6160 gpm)	250 m (820 ft)	25 bar (365 psi)	-40°C to 400°C (-40°F to 752°F)
<b>ESP3</b>	Sump	1300 m <sup>3</sup> /h (5700 gpm)	116 m (380 ft)	12 bar (175 psi)	to 180°C (350°F)
<b>PolyChem™ VGRP</b>	Sump	565 m <sup>3</sup> /h (2500 gpm)	110 m (350 ft)	17 bar (250 psi)	-30°C to 90°C (-20°F to 200°F)
<b>VPL1700</b>	Sump	182 m <sup>3</sup> /h (800 gpm)	244 m (800 ft)	—	-51°C to 52°C (-60°F to 125°F)
<b>ECPJ</b>	Sump	1000 m <sup>3</sup> /h (4400 gpm)	150 m (500 ft)	20 bar (285 psi)	to 350°C (660°F)



Worthington

### WET-PIT WUJ

Highly engineered heavy-duty, multistage vertical pump for wet-pit or deep well applications requiring continuous, unspared duty in a variety of severe services. Meets or exceeds ISO 13709/API 610 (VS1).

- Maximum design and operating flexibility enabled by modular design system along with mixed or radial flow hydraulics, which enable precise configuration
- Unspared reliability owing to under-critical stiff shaft design, separate axial thrust bearing assembly and pressure-containing parts certified to international standards
- Economical retention of operating efficiency and mechanical stability with casing and impeller wear rings
- Reduced maintenance with flanged spacer-type coupling that permits easy access to the thrust bearings and mechanical seals without disturbing the motor

#### SPECIFICATIONS

Flows to: 3000 m<sup>3</sup>/h (13 200 gpm)  
Heads to: 2000 m (6560 ft)  
Press. to: 200 bar (2900 psi)  
Temp: -200°C to 350°C  
(-328°F to 660°F)

Refer to literature PS-40-8  
at [flowserve.com/library](http://flowserve.com/library).



Flowserve

### WET-PIT VTP

Diffuser-type, single or multistage vertical turbine pump for use in wet-pit or deep well applications in a variety of industries, including oil and gas, power, water, chemical, mining and metals.

- Unsurpassed hydraulic coverage with more than 300 bowl and impeller designs to ensure optimum pump selection
- Design flexibility arising from a wide variety of configurations, constructions and materials to suit application requirements; standard and ISO 13709/API 610 (VS1) units available
- Lower operating costs from available aftermarket rebowl services that revitalize aged VTPs — including competitor models — to reduce power consumption, downtime and maintenance costs

#### SPECIFICATIONS

Flows to: 13 600 m<sup>3</sup>/h (60 000 gpm)  
Heads to: 700 m (2300 ft)  
Press. to: 100 bar (1450 psi)  
Temp: -73°C to 200°C  
(-100°F to 400°F)

Refer to literature PS-40-4  
at [flowserve.com/library](http://flowserve.com/library).



Worthington

### WET-PIT QL and QLQ

Double-suction, twin-volute vertical turbine pumps in single (QL) or multistage (QLQ) designs. ISO 13709/API 610 (VS2) compliant units available.

- Superior performance from innovative, double-suction impeller that produces more flow and higher head at lower NPSHR
- High uptime with sealed-for-life bottom bearing plus heavy-duty discharge head and integral line shaft bracket, which ensure shaft concentricity and alignment
- High operating efficiency promoted by renewable impeller wear rings that restore original clearances
- Reliable performance in applications containing silt or abrasive solids owing to optional enclosed lineshaft construction

#### SPECIFICATIONS

Flows to: 25 000 m<sup>3</sup>/h (110 000 gpm)  
Heads to: 500 m (1640 ft)  
Press. to: 70 bar (1015 psi)  
Temp: -45°C to 204°C (-50°F to 400°F)

Refer to literature PS-40-6  
at [flowserve.com/library](http://flowserve.com/library).

# VERTICAL

WET-PIT

## VCT

Mixed-flow circulating pump designed for continuous duty wet-pit applications requiring large capacities at relatively low heads. Often used in power plants, desalination, cooling water, drainage, flood protection and water supply.

- Reliable, efficient performance assured by a five-mitered elbow discharge head designed to reduce friction loss
- Outstanding operating efficiency arising from multiple hydraulic combinations that allow precise configuration
- Longer service life due to an inner column enclosing tube that is internally pressurized to lubricate bearings and prevent shaft and bearing damage during operation
- Design flexibility with above- or below-grade discharge, pullout and non-pullout designs, plus grease, freshwater or self-lubricating column constructions

### SPECIFICATIONS

Flows to: 181 700 m<sup>3</sup>/h (800 000 gpm)  
Heads to: 110 m (350 ft)

Refer to literature PS-40-6  
at [flowserve.com/library](http://flowserve.com/library).



Flowserve

WET-PIT

## AFV

The AFV axial flow suspended shaft vertical pump is a single-stage, propeller-type design. This pump is designed for low head movement of water for municipal, agricultural and industrial services.

- Optimal performance from a flared suction bell that provides a smooth entrance to the impeller and has integral splitters to reduce swirl and entrance losses
- Improved reliability resulting from a hydraulically balanced three- or four-vane axial flow propeller and top propeller hub wear ring to reduce axial down thrust
- Installation versatility provided by a discharge elbow that can be located above or below ground at any orientation
- Design flexibility with pullout or non-pullout construction, packing or mechanical seal, drive options, and optional enclosed lineshaft with oil or freshwater lubrication

### SPECIFICATIONS

Flows to: 181 700 m<sup>3</sup>/h (800 000 gpm)  
Heads to: 11 m (35 ft)

Refer to literature PS-40-3  
at [flowserve.com/library](http://flowserve.com/library).



Flowserve

WET-PIT

## Barge VTP

Vertical self-contained, self-priming unit designed for barge unloading and transfer operations. Innovative pollution prevention design inhibits costly oil and chemical spills.

- Reduced stripping turnaround times assured by a self-priming stripper stage that operates efficiently at extremely low submergence levels
- Fewer costly oil and chemical spills owing to a bleed off stuffing box that diverts product bypass back to the compartment via a sealed return line
- Ease of maintenance resulting from large ports that allow access to the stuffing box without removing the driver

### SPECIFICATIONS

Flows to: 1035 m<sup>3</sup>/h (5000 gpm)  
Heads to: 120 m (400 ft)  
Press. to: 8.6 bar (125 psi)  
Temp: -18°C to 150°C (0°F to 300°F)

Refer to literature PSS-40-7.2  
at [flowserve.com/library](http://flowserve.com/library).



Flowserve



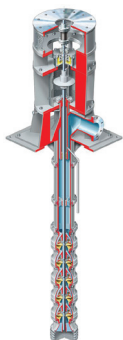

Flowserve

## WET-PIT

## Molten Salt VTP

Single or multistage vertical turbine pump engineered for molten salt circulation in concentrated solar power plants. Designed using advanced thermal mapping software to ensure adequate heat dissipation and mitigate distortion.

- Increased energy generation due to low pump submergence
- Longer service life at high temperatures assured by advanced heat dissipation design that prevents distortion
- Materials engineered to equalize thermal growth
- Advanced fluid sealing system protects against fluid leakage

## SPECIFICATIONS

Flows to: 13 600 m<sup>3</sup>/h (60 000 gpm)  
Heads to: 530 m (1740 ft)  
Press. to: 100 bar (1450 psi)  
Temp: to 600°C (1100°F)

Refer to literature FPD-16  
at [flowserve.com/library](http://flowserve.com/library).

## Harnessing the Power of the Sun

Flowserve pumps can take the heat. They play a key role at the world's first commercial concentrated solar power plant utilizing a central tower receiver with thermal storage capabilities, located in Spain. At the heart of the plant are seven Flowserve vertical turbine pumps (VTPs) specially configured to handle the molten salt heat transfer fluid at temperatures up to 600°C (1100°F) and pressures up to 100 bar (1450 psi).

Photo: Gemasolar Plant. Property of Torresol Energy © Torresol Energy



## DOUBLE-CASE

## QLC and QLQC

Double-suction vertical turbine pumps in single (QLC) or multistage (QLQC) units featuring true twin volutes. ISO 13709/API 610 (VS2) compliant design available.



Worthington

- Superior performance from innovative, double-suction impeller that produces more flow and higher head at lower NPSHR
- High uptime with sealed-for-life bottom bearing plus heavy-duty discharge head and integral line shaft bracket, which ensure shaft concentricity and alignment
- High operating efficiency promoted by renewable impeller wear rings that restore original clearances
- Reliable performance in applications containing silt or abrasive solids owing to optional enclosed lineshaft construction

## SPECIFICATIONS

Flows to: 25 000 m<sup>3</sup>/h (110 000 gpm)  
Heads to: 500 m (1640 ft)  
Press. to: 70 bar (1015 psi)  
Temp: -45°C to 204°C (-50°F to 400°F)

Refer to literature PS-40-4  
at [flowserve.com/library](http://flowserve.com/library).

# VERTICAL

## DOUBLE-CASE

### VPC

Diffuser-type, vertical turbine pump well-suited for closed system and low NPSH applications. Available in single or multistage units, as well as standard and ISO 13709/API 610 (VS6) compliant designs.

- Broad application versatility due to extensive hydraulic coverage plus wide variety of configurations, constructions and materials to suit application requirements
- Lower installation costs with low NPSH first-stage impeller that reduces suction can length
- Lower operating costs from available aftermarket rebovl services that revitalize aged VPCs — including competitor models — to reduce power consumption, downtime and maintenance costs

#### SPECIFICATIONS

Flows to: 13 600 m<sup>3</sup>/h (60 000 gpm)  
Heads to: 1070 m (3500 ft)  
Press. to: 100 bar (1450 psi)  
Temp: -73°C to 230°C  
(-100°F to 450°F)

Refer to literature PS-40-2  
at [flowserve.com/library](http://flowserve.com/library).



Flowserve

## DOUBLE-CASE

### WUC

Compliant with ISO 13709/API 610 (VS6), the WUC is a highly engineered heavy-duty, multistage process vertical pump designed for continuous duty in critical applications at high pressures and temperatures.

- Maximum design and operating flexibility enabled by modular design system, along with mixed or radial flow hydraulics that enable precise configuration
- Unspared reliability owing to stiff shaft construction, a self-contained axial thrust bearing housing and pressure-containing parts certified to international standards
- Reduced maintenance with flanged spacer type coupling that permits easy access to the thrust bearings and mechanical seals
- Reliable cryogenic operation made possible by an available coffer dam system, which provides a gas barrier between pumped fluid and mechanical seal

#### SPECIFICATIONS

Flows to: 3000 m<sup>3</sup>/h (13 200 gpm)  
Heads to: 2000 m (6560 ft)  
Press. to: 200 bar (2900 psi)  
Temp: -200°C to 350°C  
(-328°F to 660°F)

Refer to literature PS-40-9  
at [flowserve.com/library](http://flowserve.com/library).



Worthington

## DOUBLE-CASE

### APKD

The APKD is ideal for critical services with limited NPSHA. An innovative double-suction impeller in a true twin-volute design produces more flow and higher head at lower NPSHR.

- Lower energy consumption and operating costs provided by a versatile series of impeller design options that enable optimum hydraulic fit
- Wide operating range with multiple suction-specific speed options
- Reliable operation with balanced hydraulic loads owing to double-suction, twin-volute design

#### SPECIFICATIONS

Flows to: 4600 m<sup>3</sup>/h (20 200 gpm)  
Heads to: 500 m (1640 ft)  
Press to: 50 bar (725 psi)  
Temp: -18°C to 200°C (0°F to 400°F)

Refer to literature PS-40-10  
at [flowserve.com/library](http://flowserve.com/library).



Flowserve



Byron Jackson

## DEEP-WELL

## Byron Jackson SUBM Pump With H2O Motor

Water-filled, wet-wound motors are environmentally friendly, provide high efficiency, and offer outstanding reliability — an exceptional value suitable for potable water applications.

- Non-toxic operation, improved cooling and extended motor life enabled by Class Y winding insulation system
- Prolonged product life enhanced by induction motor and heavy-duty, self-aligning sleeve bearings
- Ease of installation and ambient temperature flexibility with pre-filled water and antifreeze motor lubrication
- Fast delivery in one to four weeks available for sizes 6 through 10 in via H2O+ pump quick-delivery program

## SPECIFICATIONS

Flows to: 6000 m<sup>3</sup>/h (26 415 gpm)  
 Heads to: 800 m (2625 ft)  
 Motor Sizes to: 1650 kW (2200 hp)  
 Refer to literature PUBR000208  
 at [flowserve.com/library](http://flowserve.com/library).



Byron Jackson

## DEEP-WELL

## Byron Jackson SUBM Pump With OIL Motor

Oil-filled submersible motor pump built for the world's most demanding deep-well services. Rugged, reliable and long-lasting, the Byron Jackson SUBM offers significant total lifecycle cost savings.

- Extended motor service life enabled by induction motor plus Class H insulation system designed with vacuum-pressure impregnated epoxy, re-windable stators and internal circulation system
- Maximum pump efficiency with minimum vibration provided by dynamically balanced heavy-duty impellers and bowl cases
- Ease of installation with sealed power cable plug-in feature, which eliminates field splicing
- Precise configuration for application needs owing to numerous hydraulic, cooling, lubrication, sealing, materials and accessory options

## SPECIFICATIONS

Flows to: 6000 m<sup>3</sup>/h (26 415 gpm)  
 Heads to: 800 m (2625 ft)  
 Motor Sizes to: 1650 kW (2200 hp)  
 Refer to literature PUBR000208  
 at [flowserve.com/library](http://flowserve.com/library).

### Life-Giving Water in Thailand

Thailand's Royal Irrigation Department chose Flowserve to help provide its people with dependable irrigation and flood control. For years the people living in the 3.65 million acre Pasak River Basin, north of Bangkok, suffered cycles of drought and flood. No longer. With the construction of a dam employing vertical mixed flow pumps from Flowserve, the people are protected from flooding and have adequate water to grow crops.

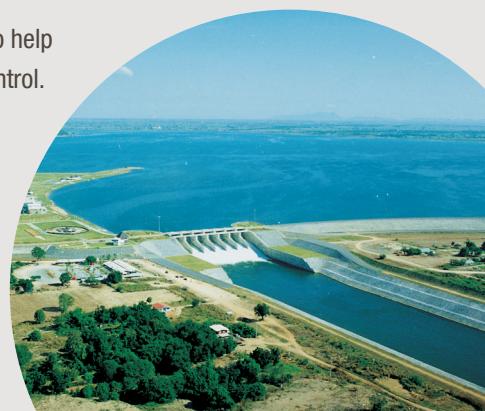

# VERTICAL

## SLURRY

### MJ and MJC

Vertical lineshaft (MJ) and cantilever (MJC) hard-metal slurry pumps designed for services containing coarse solids in suspension (to 70% by weight). Suitable for a broad range of wet- and dry-pit services.

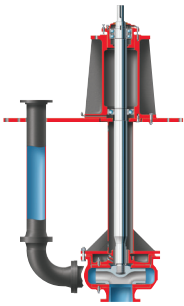

Worthington

- Increased uptime provided by extra-thick wear allowances
- Efficient operation and prolonged service life as a result of concentric casing and anti pre-rotation vanes, which reduce suction pipe swirl and impeller wear
- Extended seal and bearing life enabled by closed impeller with pump-out vanes, which reduces stuffing box pressure and suction recirculation as well as balances axial hydraulic loads
- Reduced inventory costs from parts interchangeability among related horizontal and vertical configurations

#### SPECIFICATIONS

Flows to: 1350 m<sup>3</sup>/h (6000 gpm)  
Heads to: 30 m (100 ft)  
Press. to: 10 bar (150 psi)  
Temp: to 110°C (225°F)

For more information, refer to PS-10-19.

Refer to literature PS-10-19 at [flowserve.com/library](http://flowserve.com/library).

## SLURRY

### RJ and RJC

Rubber-lined lineshaft (RJ) and cantilever (RJC) slurry pumps designed to handle services containing fine solids in suspension (to 70% by weight). Suitable for a broad range of wet- and dry-pit applications.

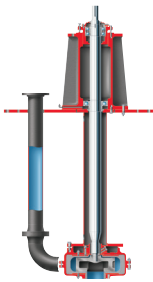

Worthington

- Low total cost of ownership provided by replaceable rubber liners
- Extended seal and bearing life enabled by rubber-closed impeller with pump-out vanes, which reduces stuffing box pressure and suction recirculation as well as balances axial hydraulic loads
- Efficient operation and prolonged service life as a result of concentric casing and anti pre-rotation vanes, which reduce suction pipe swirl and impeller wear
- Reduced inventory costs from parts interchangeability among related horizontal and vertical configurations

#### SPECIFICATIONS

Flows to: 1350 m<sup>3</sup>/h (6000 gpm)  
Heads to: 30 m (100 ft)  
Press. to: 10 bar (150 psi)  
Temp: to 110°C (225°F)

Refer to literature PS-10-18 at [flowserve.com/library](http://flowserve.com/library).

## SLURRY

### Terra-Titan

This vertical cantilever shaft sump pump is ruggedly built to provide economic reliability demanded by mining, process and general industries.



TKL

- Reliable, long-lasting performance due to rigid one-piece suspended, oversized cantilever shaft design, which reduces vibration and tolerates run-dry operation
- Reduced maintenance with renewable Terraprene shaft sleeve that eliminates shaft wear within the casing
- Ease of maintenance and efficient operation via external impeller adjustment, which provides simple way to adjust clearances for special applications
- Application versatility provided by low-mounted motor, taper lock bushes and V-belt drive, which allow simple adaptation to suitable pump speeds

#### SPECIFICATIONS

Flows to: 250 m<sup>3</sup>/h (1100 gpm)  
Heads to: 45 m (150 ft)  
Press. to: 5 bar (70 psi)  
Temp: to 100°C (212°F)

Refer to literature PS-10-7 at [flowserve.com/library](http://flowserve.com/library).

## SLURRY

## VPL3300

Designed specifically for difficult titanium tetrachloride (TiCl<sub>4</sub>) applications in pigments processing, the VPL3300 pump is a true cantilever design with a rugged wet-end construction ideal for this volatile toxic slurry.

- Excellent abrasion resistance and longevity ensured by special slurry wet end made from thick-walled, high-chrome iron
- Reduced wear and recirculation delivered by an impeller that incorporates repelling vanes specifically designed for erosive services
- Durability and long pump life made possible by heavy-duty, anti-friction thrust and radial bearings located above liquid level

## SPECIFICATIONS

Flows to: 4542 m<sup>3</sup>/h (20 000 gpm)  
Heads to: 91 m (300 ft)  
Temp: to 593°C (1100°F)



Lawrence Pumps

## SLURRY

## VPL3600

Designed specifically for the coke pit maze application found in decoking units, the rugged VPL3600 vertical slurry pump provides long life in tough, erosive slurry applications. Compliant with ISO 13709/API 610 (VS4).

- Reliable operation ensured by the water-filled column with restriction bushing, which maintains a clean environment for the shaft and sleeve bearings
- Excellent abrasion resistance and longevity ensured by special slurry wet end made from thick-walled, high-chrome iron
- Reduced wear and recirculation delivered by an impeller that incorporates repelling vanes specifically designed for erosive services
- Available sparger system helps to keep coke particles in suspension to prevent sifting-in of the pump; mechanical agitation systems also available

## SPECIFICATIONS

Flows to: 1500 m<sup>3</sup>/h (6600 gpm)  
Heads to: 150 m (492 ft)  
Temp: to 100°C (212°F)

Refer to literature PS-40-12 at [flowserve.com/library](http://flowserve.com/library).

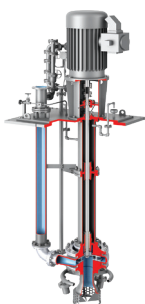

Lawrence Pumps

## SOLIDS HANDLING

## MVX

The Flowserve MVX is a rugged wet-pit pump designed for use in solids-handling applications and other wet-pit services. Built and tested in accordance with Hydraulic Institute standards.

- Smooth performance with symmetrical bowl with multi-volute design that provides hydraulic balance
- Resistance to clogging from solids or stringy materials enabled by splitter guide vanes and enclosed non-clog impeller
- Longer service life provided by the enclosed lineshaft, which protects bearing surfaces from abrasion
- Smallest model passes spherical solids to 76 mm (3 in) diameter; larger models pass spherical solids to 152 mm (6 in) diameter

## SPECIFICATIONS

Flows to: 17 000 m<sup>3</sup>/h (75 000 gpm)  
Heads to: 40 m (130 ft)  
Press. to: 7 bar (100 psi)  
Temp: to 40°C (104°F)  
Motor to: 950 kW (1250 hp)

Refer to literature PS-4-5 at [flowserve.com/library](http://flowserve.com/library).



Flowserve

# VERTICAL

## SUMP

### CPXV

Compliant with ISO 5199, the CPXV chemical sump pump offers efficient and reliable service in a broad range of applications. Available with many ISO 13709/API 610 compliant features for oil and gas installations.

- Highly customizable, with more than 40 hydraulic wet-ends, numerous materials, multiple mechanical seal options and column lengths to 10 m (32 ft)
- High-efficiency performance delivered by standard front vane open-style impeller
- Ease of maintenance with axial adjustment of the heavy-duty thrust bearings made above sole plate level
- Fully jacketed molten sulfur configuration available
- Increased safety with Category 1 (Zone 0) ATEX configuration for explosive atmospheres beneath the sole plate

#### SPECIFICATIONS

Flows to: 1400 m<sup>3</sup>/h (6160 gpm)  
Heads to: 250 m (820 ft)  
Press. to: 25 bar (365 psi)  
Temp: -40°C to 400°C (-40°F to 752°F)

Refer to literature PS-10-31  
at [flowserve.com/library](http://flowserve.com/library).



IDP

## SUMP

### ESP3

This ruggedly built vertical, chemical sump pump is designed to provide improved performance, increased part standardization and reduced inventory costs.

- Increased parts standardization and reduced inventory costs from the only vertical wet-pit immersion sump pump to offer parts interchangeability with standard ASME B73.1 horizontal pumps (Durco Mark 3)
- Repeatable performance for the life of the pump due to reverse vane impeller
- Reduced maintenance and downtime in difficult process fluids owing to a wide array of wetted materials, bearing materials and flush plan options
- Low total cost of ownership made possible by many features designed to reduce costs associated with installation and maintenance

#### SPECIFICATIONS

Flows to: 1300 m<sup>3</sup>/h (5700 gpm)  
Heads to: 116 m (380 ft)  
Press. to: 12 bar (175 psi)  
Temp: to 180°C (350°F)

Refer to literature PS-10-24  
at [flowserve.com/library](http://flowserve.com/library).



IDP

## SUMP

### PolyChem VGRP

Engineered glass-reinforced polymer composite overhung sump pump offering cost-effective corrosion resistance in a lightweight, non-galling, non-sparking and non-conductive design.

- Corrosion resistance superior to more expensive high-alloy metals, which provides a lower investment cost and long-term solution in acid- and chloride-rich applications
- High efficiencies and reduced maintenance due to externally adjustable, semi-open impeller that is inherently balanced
- Increased uptime and longer bearing life provided by shaft/bearing system, which operates well below the first critical speed and results in less whip
- Ease of maintenance due to design of pull-out bearing retainer

#### SPECIFICATIONS

Flows to: 565 m<sup>3</sup>/h (2500 gpm)  
Heads to: 110 m (350 ft)  
Press. to: 17 bar (250 psi)  
Temp: -30°C to 90°C (-20°F to 200°F)

Refer to literature PS-10-17  
at [flowserve.com/library](http://flowserve.com/library).



Durco



Lawrence Pumps

## SUMP

## VPL1700

Designed specifically for transferring toxic liquids (e.g., chlorine, phosgene and anhydrous cyanide), the VPL1700 multistage, vertical line shaft, top-entry, tank-mounted pump is designed for maximum safety and reliability.

- Personnel safety maximized with shaft sealing and hydraulic upgrades such as emergency seals and excess flow check valves
- Highly configurable, with numerous materials of construction and optional upgrades to maximize safety, reliability and ease of maintenance
- Lowest fugitive emissions made possible by special gas seal design
- Reliability assured by an available instrumentation package that controls the flow of buffer gas to the seal chamber and monitors critical operating parameters

## SPECIFICATIONS

Flows to: 182 m<sup>3</sup>/h (800 gpm)  
 Heads to: 244 m (800 ft)  
 Temp: -51°C to 52°C  
 (-60°F to 125°F)



Worthington

## SUMP

## ECPJ

This rugged, single-stage, vertical-lineshaft sump pump is a proven performer in tough chemical and hydrocarbon processing applications. Fully compliant with ISO 13709/API 610 (VS4).

- Dependable performance and extensive mechanical and hydraulic design flexibility resulting from the ability to custom engineer each pump for its specific application
- Greater reliability with lower inventory costs enabled by thrust pot design that permits standard (non-thrust) electrical motors to be used
- Smooth operation over a wide flow range ensured by dynamically balanced precision-cast impeller
- Improved low-flow, high-head performance with available Barske-type impeller
- Steam-jacketed version for liquid sulfur service available

## SPECIFICATIONS

Flows to: 1000 m<sup>3</sup>/h (4400 gpm)  
 Heads to: 150 m (500 ft)  
 Press. to: 20 bar (285 psi)  
 Temp: to 350°C (660°F)

Refer to literature PS-10-10 at [flowserve.com/library](http://flowserve.com/library).

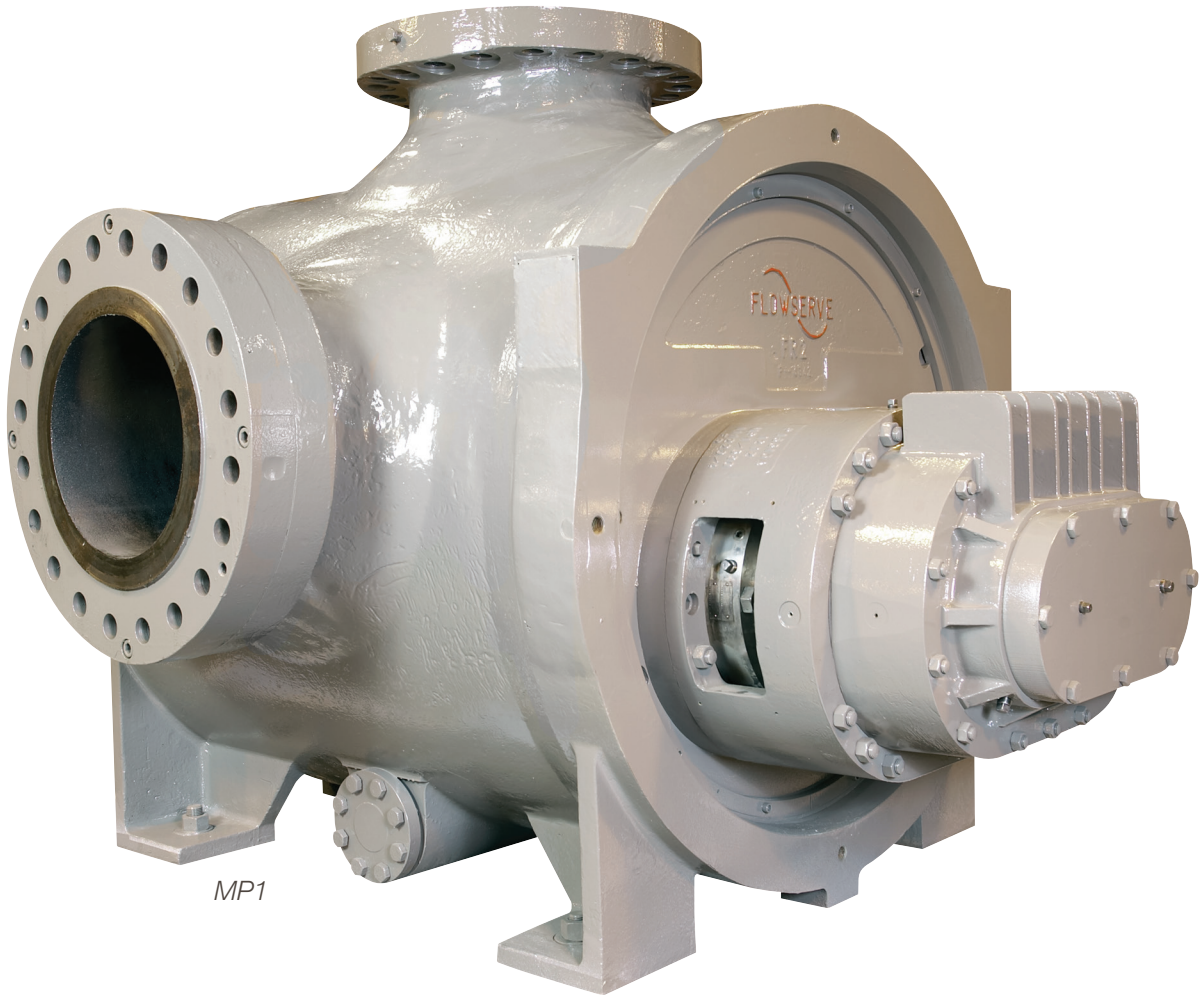

MP1



## POSITIVE DISPLACEMENT

Reliable performance in tough applications is achieved through robust power transmission and heavy-duty liquid ends for every Flowserve positive displacement pump. Our versatile range of diaphragm, gear and screw configurations helps customers avoid costly upfront costs with durable, high-speed designs. Long service intervals that keep plants running are the norm, even in ultra-high viscosity and multiphase fluid applications.

### Positive Displacement – Quick Reference

Product	Sub-Type	Flows to	Pressures to	Temperatures
<b>CT6</b>	Diaphragm	4 m <sup>3</sup> /h (18 gpm)	—	—
<b>GR</b>	Gear	275 m <sup>3</sup> /h (1200 gpm)	35 bar (500 psi)	to 350°C (650°F)
<b>GA</b>	Gear	27 m <sup>3</sup> /h (120 gpm)	17 bar (250 psi)	to 175°C (350°F)
<b>Gearex</b>	Gear	180 m <sup>3</sup> /h (800 gpm)	20 bar (300 psi)	-50°C to 450°C (-60°F to 842°F)
<b>TSP</b>	Twin Screw	2550 m <sup>3</sup> /h (11 200 gpm)	100 bar (1450 psi)	to 450°C (842°F)
<b>MP1</b>	Multiphase Twin Screw	2250 m <sup>3</sup> /h (10 000 gpm)	50 bar (720 psi)	to 450°C (850°F)

# POSITIVE DISPLACEMENT

## DIAPHRAGM

### CT6



Scienco™

With market-leading flow rates, the CT6 self-priming diaphragm pump is the premier solution for agricultural and DEF transfer needs. For use with caged IBCs, mini bulk tanks and drums.

- Broad application versatility enabled by a variety of mounting configurations, input voltages, brackets, dip tubes, flow meters, fittings, hoses and valves to meet application needs
- Ease of use provided by a complete, out-of-the-box system and self-priming from a dry state
- Time-saving, efficient chemical transfer facilitated by market-leading flow rates
- Two-year limited warranty

#### SPECIFICATIONS

Flows to: 4 m<sup>3</sup>/h (18 gpm)

Refer to literature PSS-90-20.23 and PSS-90-20.24 at [flowserve.com/library](http://flowserve.com/library).

## GEAR

### GR

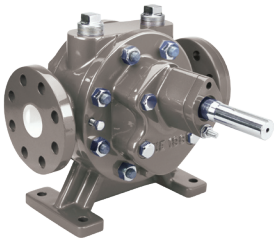

Worthington

GR pumps provide high efficiency, pulse-free pumping, even under challenging conditions. They are designed to handle viscous fluids (up to 20 000 cP) across a broad spectrum of flows and pressures.

- Increased uptime while accommodating heavy, highly viscous loads made possible by double-helical herringbone gears and between-bearings design
- Lower operating costs provided by high-speed capability, which eliminates expensive speed reduction accessories and enables the use of off-the-shelf motors
- Application flexibility facilitated by convertible stuffing box, which allows for ample packing or mechanical seals

#### SPECIFICATIONS

Flows to: 275 m<sup>3</sup>/h (1200 gpm)

Press. to: 35 bar (500 psi)

Temp to: 350°C (650°F)

Refer to literature PS-60-4 at [flowserve.com/library](http://flowserve.com/library).

## GEAR

### GA

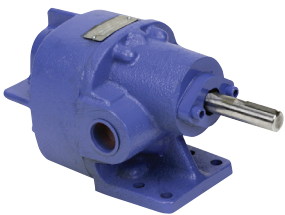

Worthington

GA cast iron gear pumps have long been workhorses in highly viscous applications (to 5000 cP) within a multitude of industries due to their reliability, efficiency and low total lifecycle costs.

- Dependable, quiet, pulse-free operation made possible by superior between bearings design and external double-helical, herringbone gear design
- Lower operating costs provided by high-speed capability, which eliminates expensive speed reduction accessories and enables the use of off-the-shelf motors
- Reduced maintenance with inherently hydraulically balanced design that eliminates end thrust and the need for thrust bearings
- Convertible stuffing box, which allows for ample packing or mechanical seals

#### SPECIFICATIONS

Flows to: 570 m<sup>3</sup>/h (2500 gpm)

Press. to: 17 bar (250 psi)

Temp: 175°C (350°F)

Refer to literature PS-60-4 at [flowserve.com/library](http://flowserve.com/library).

## GEAR

## Gearex

Extremely rugged and unusually compact for its high capacity and range, the Gearex rotary pump is generally compliant with API 676, second edition. Handles viscosities to 20 000 cP.

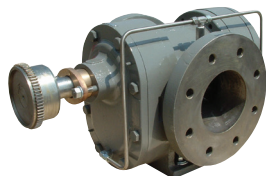

Worthington

- Long, reliable operation due to precision-machined herringbone pumping gears that provide low vibration, pulseless discharge while timing gears transfer power with minimal wear
- Lower total cost of ownership derived from ability to directly connect to motors up to 1800 rpm, eliminating the need for heavy foundation, belts or reduction gears
- Increased uptime via heavy-duty ball and roller bearings, which support the rotating element to prevent contact with the housing
- Reduced downtime with split brackets facilitate seal maintenance

## SPECIFICATIONS

Flows to: 180 m<sup>3</sup>/h (800 gpm)  
 Press. to: 20 bar (300 psi)  
 Temp: -50°C to 450°C (-60°F to 842°F)  
 Refer to literature PS-60-4  
 at [flowserve.com/library](http://flowserve.com/library).

## TWIN SCREW

## TSP

Built in accordance with API 676, the TSP double-suction, timed twin-screw pump improves upon traditional rotary pump designs by providing smoother, more constant flow.

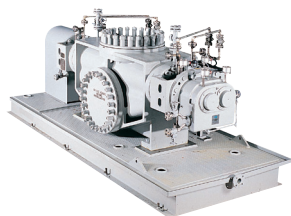

Sier-Bath

- Increased availability, especially in fluids that are contaminated or have poor lubricity, assured by external bearings and AGMA 11 timing gears, which are housed in separate oil reservoirs to eliminate exposure to pumped fluid
- Application versatility provided by high volumetric efficiency over a wide range of viscosities (up to 55 million cP), run-dry capability and ISO 21049/API 682 seal chamber that accommodates multiple seal types
- Ease of maintenance with split bearing brackets that provide access to the bearings and seals

## SPECIFICATIONS

Flows to: 2550 m<sup>3</sup>/h (11 200 gpm)  
 Diff. Press. to: 100 bar (1450 psi)  
 Temp: 450°C (842°F)  
 Refer to literature PS-60-1  
 at [flowserve.com/library](http://flowserve.com/library).

## MULTIPHASE TWIN SCREW

## MP1

Compliant with API 676, the MP1 is engineered for reliability in the toughest multiphase upstream oil field applications. Handles viscosities to 8000 cP, slurries to 70% solids by weight and gas volume fractions (GVF) to 100%

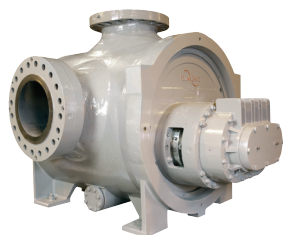

Flowserve

- Rugged and versatile operation that readily accommodates rapid changes in viscosities, gas-to-liquid ratios and GVF
- Reliable, efficient performance from one-piece integral rotor and double-suction design, which provides balanced hydraulic loads
- High availability due to external bearings and AGMA 11 timing gears, which are housed in separate oil reservoirs to eliminate exposure to pumped fluid
- Easy access to bearings and seals with split bearing brackets
- Safety and environmental compliance with ISO 21049/API 682 seal chamber

## SPECIFICATIONS

Flows to: 2250 m<sup>3</sup>/h (10 000 gpm)  
 Diff. Press. to: 50 bar (720 psi)  
 Temp: to 450°C (850°F)  
 Refer to literature PS-60-2  
 at [flowserve.com/library](http://flowserve.com/library).

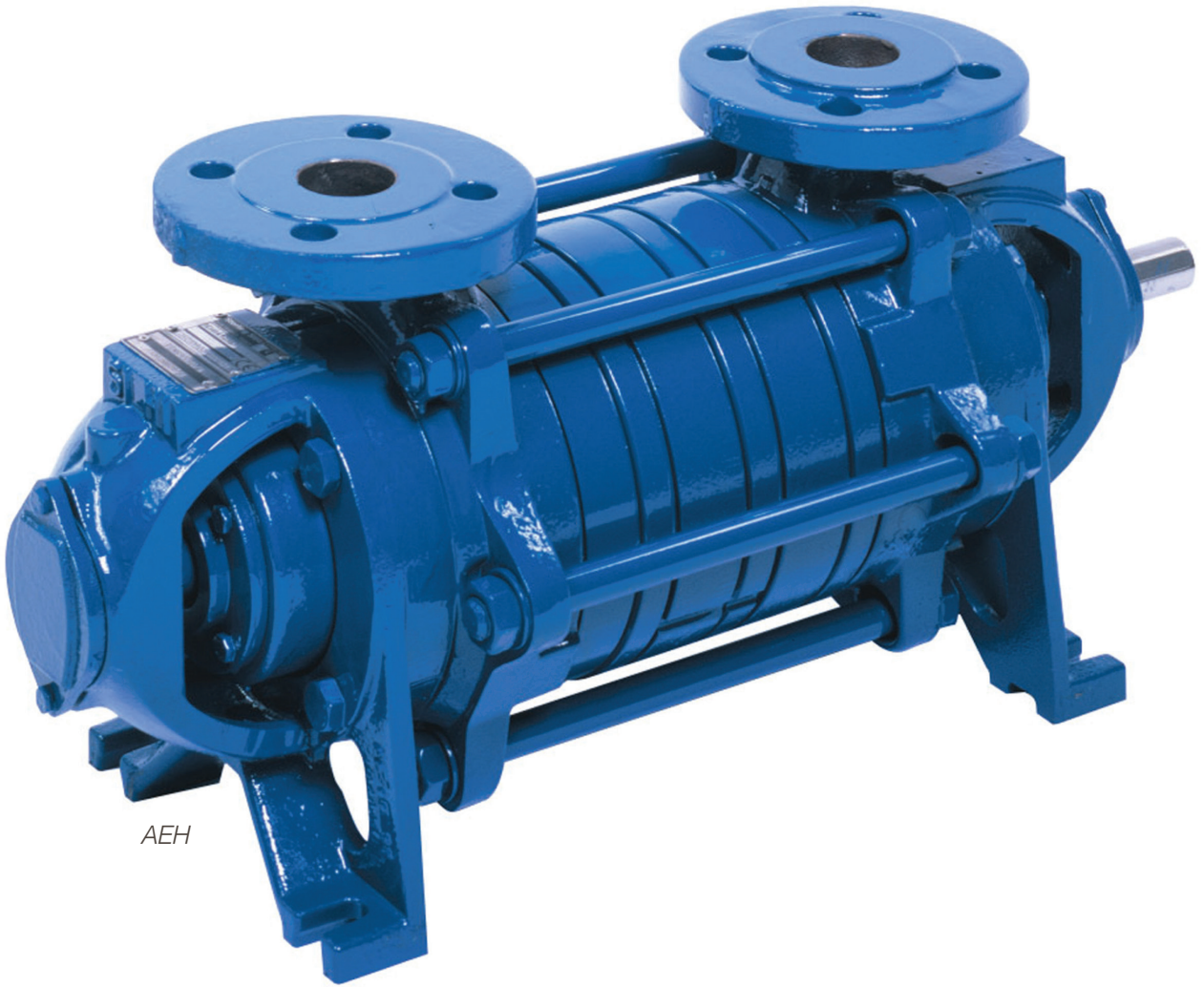

AEH

## SIDE CHANNEL

For problem-free, low-flow, high-head pumping under unfavorable suction conditions, our SIH side channel pumps routinely deliver in the most difficult applications. In addition to being self-priming, innovative side channel hydraulics ensure superior process control and gas-handling capability, especially when pumping liquids at their boiling points or with entrained gas. Cost of ownership is kept low by excellent hydraulic efficiency, simplified maintenance and a high degree of parts interchangeability.

### Side Channel – Quick Reference\*

Product	Sub-Type	Flows to	Heads to	Pressures to	Temperatures
<b>CEH</b>	Side Channel	35 m <sup>3</sup> /h (154 gpm)	354 m (1161 ft)	40 bar (580 psi)	to 180°C (356°F)
<b>AEH</b>	Side Channel	35 m <sup>3</sup> /h (154 gpm)	354 m (1161 ft)	40 bar (580 psi)	to 180°C (356°F)
<b>AKH</b>	Side Channel	35 m <sup>3</sup> /h (154 gpm)	242 m (794 ft)	25 bar (363 psi)	to 120°C (248°F)
<b>AOH</b>	Side Channel	7.5 m <sup>3</sup> /h (33 gpm)	98 m (322 ft)	10 bar (145 psi)	to 120°C (248°F)
<b>ASH</b>	Side Channel	12 m <sup>3</sup> /h (53 gpm)	288 m (945 ft)	100 bar (1450 psi)	to 120°C (248°F)
<b>ADH</b>	Side Channel	7.2 m <sup>3</sup> /h (32 gpm)	400 m (1312 ft)	25 bar (362 psi)	120°C (250°F)

\* Additional products shown on next page

## Side Channel – Quick Reference, cont'd.

Product	Sub-Type	Flows to	Heads to	Pressures to	Temperatures
<b>SC</b>	Side Channel	65 l/min (17 gpm)	—	25 bar (362 psi)	80°C (to 176°F)
<b>SMX</b>	Side Channel	100 l/min (26 gpm)	—	—	-20°C to 40°C (-4°F to 104°F)
<b>CEB</b>	Side Channel	65 l/min (17 gpm)	—	40 bar (580 psi)	-40°C to 60°C (-40°F to 140°F)
<b>DRV</b>	Side Channel	2 m <sup>3</sup> /h (17 gpm)	27 m (88 ft)	6 bar (218 psi)	100°C (212°F)
<b>AKL and AKV</b>	Side Channel	12 m <sup>3</sup> /h (50 gpm)	70 m (230 ft)	16 bar (230 psi)	120°C (250°F)

## SIDE CHANNEL

## CEH



SIHI

A centrifugal combined system, the CEH is self-priming and provides reliable pumping under unfavorable suction conditions. It is ideal for pumping liquids under vapor pressure, such as condensates, refrigerants and liquefied gases.

- Problem-free pumping in applications with NPSHA below 0.5 m (1.64 ft) due to centrifugal-combined system construction, which employs a centrifugal inducer stage before the side channel stages to lower NPSHR
- Excellent hydraulic efficiency assured by modular side-channel system with one to eight stages which permits precise configuration for operating parameters
- Low inventory carrying costs and simplified maintenance enabled by high degree of parts interchangeability between stages

## SPECIFICATIONS

Flows to: 35 m<sup>3</sup>/h (154 gpm)  
Heads to: 354 m (1161 ft)  
Press. to: 40 bar (580 psi)  
Temp: to 180°C (356°F)

Refer to literature PS-120-1 at [flowserve.com/library](http://flowserve.com/library).

## SIDE CHANNEL

## AEH



SIHI

The AEH is a self-priming pump designed per DIN EN 734. It is well-suited for a wide range of applications across industries, including pure, turbid or aggressive media as well as gas-entrained fluids.

- Excellent gas-handling capability due to segmental-type construction with open-vane wheel impellers
- Application versatility made possible by numerous options, including materials, bearing arrangements, sealing systems and couplings
- High-efficiency operation assured by modular side-channel system with one to eight stages, which permits precise sizing for BEP operation
- Reduced spare parts and ease of maintenance made possible by a high degree of parts interchangeability between stages

## SPECIFICATIONS

Flows to: 35 m<sup>3</sup>/h (154 gpm)  
Heads to: 354 m (1161 ft)  
Press. to: 40 bar (580 psi)  
Temp: to 180°C (356°F)

Refer to literature PS-120-1 at [flowserve.com/library](http://flowserve.com/library).

## SIDE CHANNEL

## AKH



SIHI

The AKH provides trouble-free pumping in a broad range of medium-duty applications in the chemical, oil and general industries, plus naval applications and DAF systems.

- Superior process control due to a steep performance curve that ensures rigorous regulation of the pressure with small changes in capacity
- Application flexibility due to segmental-type construction with open-vane wheel impellers, which permits reliable self-priming and gas-handling capability
- Excellent hydraulic efficiency assured by modular side-channel system with one to six stages, which allows precise sizing for BEP operation
- Low inventory carrying costs and simplified maintenance owing to a high degree of parts interchangeability between stages

## SPECIFICATIONS

Flows to: 35 m<sup>3</sup>/h (154 gpm)  
Heads to: 242 m (794 ft)  
Press. to: 25 bar (363 psi)  
Temp: to 120°C (248°F)

Refer to literature PS-120-1 at [flowserve.com/library](http://flowserve.com/library).

# SIDE CHANNEL

## SIDE CHANNEL

### AOH

The AOH is designed for low-capacity applications with clear or turbid liquids without abrasive particles. It is often used in agriculture and general industries as well as naval applications.

- Superior process control assured by a steep performance curve that ensures strict pressure regulation with nominal capacity changes
- Application flexibility arising from reliable self-priming and gas-handling capability due to segmental-type construction with open-vane wheel impellers
- Low inventory carrying costs and simplified maintenance owing to a high degree of parts interchangeability between stages

#### SPECIFICATIONS

Flows to: 7.5 m<sup>3</sup>/h (33 gpm)  
Heads to: 98 m (322 ft)  
Press. to: 10 bar (145 psi)  
Temp. to: 120°C (248°F)

Refer to literature PS-120-1 at [flowserve.com/library](http://flowserve.com/library).



SIHI

## SIDE CHANNEL

### ASH

The ASH was developed for handling liquefied gases with vapor pressures to 80 bar (1160 psi). It is particularly well-suited for general industry applications involving CO<sub>2</sub> production, storage, transportation, drying, cleaning and fire suppression.

- Superior gas handling capability due to segmental-type construction with open-vane wheel impellers
- Increased MTBF ensured by a special bearing developed to compensate for the axial forces in case of high nominal pressures

#### SPECIFICATIONS

Flows to: 12 m<sup>3</sup>/h (53 gpm)  
Heads to: 288 m (945 ft)  
Press. to: 100 bar (1450 psi)  
Temp. to: 120°C (248°F)

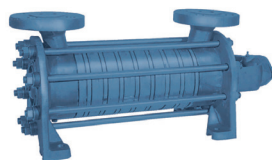

SIHI

## SIDE CHANNEL

### ADH

High-speed, segmental-type, horizontal side channel pump for use in boiler feed, condensate return, pressure boosting and marine service applications.

- Application reliability provided by self-priming side channel design capable of handling gas during normal liquid duty
- Quiet operation from unshrouded vane wheel impellers
- Longer service life due to floating impellers that reduce wear and minimize axial thrust
- Optimal performance resulting from a steep performance curve that allows precise regulation of the pressure with small changes in flow

#### SPECIFICATIONS

Flows to: 7.2 m<sup>3</sup>/h (32 gpm)  
Heads to: 400 m (1312 ft)  
Press. to: 25 bar (362 psi)  
Temp: 120°C (250°F)



SIHI



## SIDE CHANNEL

## SC

The SC is a self-priming, centrifugal combined system that provides reliable pumping under unfavorable suction conditions. It is designed for propane, butane and bottom off-loading in LPG plants.



SIHI

- Problem-free pumping in applications with NPSHA between 0.4 m and 0.65 m (1.31 ft and 2.13 ft) due to centrifugal-combined system construction, which employs a centrifugal inducer stage to lower NPSHR
- Application flexibility due to segmental-type construction with open-vane wheel impeller, which permits reliable self-priming and gas-handling capability
- Low inventory carrying costs and simplified maintenance enabled by high degree of parts interchangeability between stages

## SPECIFICATIONS

Flows to: 65 l/min (17 gpm)  
Diff. Press. to: 14.5 bar (210 psi)  
Press. to: 25 bar (362 psi)  
Temp: 80°C (to 176°F)

Refer to literature PS-120-2  
at [flowserve.com/library](http://flowserve.com/library).

## SIDE CHANNEL

## SMX

Submersible side-channel pump ideal for LPG car-filling applications. Its innovative canned motor design makes it easy to replace other submersible pumps used in most LPG car-filling stations.



SIHI

- Reliable, continuous operation and low installation cost due to an internal bypass connection that secures minimum flow and eliminates the need for an additional bypass valve
- Energy efficiency through an optional intelligent drive that allows one pump to be used for two nozzles to reduce energy consumption by adjusting performance
- Superior process control resulting from side channel hydraulics with a steep performance curve that ensures strict pressure regulation with capacity changes

## SPECIFICATIONS

Flows to: 100 l/min (26 gpm)  
Diff. Press. to: 10 bar (145 psi)  
Temp: -20°C to 40°C (-4°F to 104°F)

Refer to literature PS-120-2  
at [flowserve.com/library](http://flowserve.com/library).

## SIDE CHANNEL

## CEB

Vertical, extended tank, side channel unit for pumping liquids at their boiling point or with entrained gas. It is designed for pumping liquefied petroleum gas and other liquefied gases.



SIHI

- Reliable operation in applications with poor suction conditions due to a special suction impeller and an inducer stage that significantly lower NPSHR
- Simplified installation with vertical tank pump design that enables retrofitting into most common tanks and dimensions that support submersible pump replacement
- Reduced maintenance with sealless magnetic drive design

## SPECIFICATIONS

Flows to: 65 l/min (17 gpm)  
Diff. Press. to: 15 bar (217 psi)  
Press. to: 40 bar (580 psi)  
Temp: -40°C to 60°C (-40°F to 140°F)

Refer to literature PS-120-2  
at [flowserve.com/library](http://flowserve.com/library).

# SIDE CHANNEL

## SIDE CHANNEL

### DRV



SIHI

Single-stage, vertical side channel pump with threaded flanges. Self-priming and capable of handling entrained gas, the DRV is used in general industry, agriculture, chemical and pharmaceutical applications.

- Installation flexibility owing to compact, vertical arrangement with minimal footprint; units can even be suspended when piping systems are sufficiently stable
- Excellent gas-handling capability due to segmental-type construction with open vane wheel impellers
- Superior process control resulting from a steep performance curve that allows precise regulation of the pressure with small changes in flow

#### SPECIFICATIONS

Flows to: 2 m<sup>3</sup>/h (17 gpm)  
Heads to: 27 m (88 ft)  
Press. to: 6 bar (218 psi)  
Temp: 100°C (212°F)

## SIDE CHANNEL

### AKL and AKV



SIHI

Horizontal (AKL) or vertical (AKV), single-stage, in-line side channel pumps used in pharmaceutical, food and beverage, air conditioning and refrigeration, chemical and petrochemical applications.

- Ease of maintenance due to an opposite-arranged suction and discharge cover that allows all parts subject to wear to be replaced without detaching the pumps from the piping system
- Cost-effective choice with low installation costs due to space-saving, light-weight, in-line design
- Low inventory carrying costs and simplified maintenance enabled by high degree of parts interchangeability between stages

#### SPECIFICATIONS

Flows to: 12 m<sup>3</sup>/h (50 gpm)  
Heads to: 70 m (230 ft)  
Press. to: 16 bar (230 psi)  
Temp: 120°C (250°F)

Refer to literature PS-120-1 at [flowserve.com/library](http://flowserve.com/library).

## A Global Footprint for Local Support

Flowserve is committed to providing our customers with uncompromising support, wherever and whenever you need us. Our worldwide network of quick response centers staffed by highly skilled engineers and technicians is available around the clock, seven days a week to respond to your questions, evaluate and troubleshoot problems, and provide reliable long-term solutions.







*KPH*

## VACUUM PUMPS & COMPRESSORS

Safe, dependable performance across a range of difficult compression applications is the hallmark of our portfolio of liquid ring vacuum pumps and compressors. Customers benefit from application flexibility that keeps operating costs down, taking advantage of a broad range of capacities and pressures, as well as numerous models that leverage common components. Trouble-free operation and maximum uptime are achieved through robust designs capable of handling entrained liquid and vapor.

### Vacuum Pumps & Compressors – Quick Reference\*

Product	Sub-Type	Suction Capacity to	Suction Pressure	Compression Pressure to
<b>SIHIdry</b>	Dry Vacuum Pump	1500 m <sup>3</sup> /h (900 cfm)	<0.01 mbar (<0.007 torr)	—
<b>SIHIboost</b>	Dry Vacuum Pump	8000 m <sup>3</sup> /h (4800 cfm)	<0.001 mbar (<0.0007 torr)	—
<b>LEM and LEL</b>	Liquid Ring Vacuum Pump	470 m <sup>3</sup> /h (276 cfm)	33 to 1013 mbar (24.7 to 760 torr)	—
<b>LEH</b>	Liquid Ring Vacuum Pump	5150 m <sup>3</sup> /h (3030 cfm)	33 to 1013 mbar (24.7 to 760 torr)	—
<b>LPH</b>	Liquid Ring Vacuum Pump	12 000 m <sup>3</sup> /h (7063 cfm)	33 to 1013 mbar (24.7 to 760 torr)	—
<b>KPH</b>	Liquid Ring Compressors	11 000 m <sup>3</sup> /h (6475 cfm)	—	atmospheric to 12 barg (174 psig)

\* Additional products shown on next page

## Vacuum Pumps & Compressors – Quick Reference, cont'd.

Product	Sub-Type	Suction Capacity to	Suction Pressure	Compression Pressure to
<b>PL</b>	Vacuum Systems	10 000 m <sup>3</sup> /h (5886 cfm)	10 <sup>-3</sup> mbar (7x10 <sup>-4</sup> torr) to atmospheric	—
<b>PM</b>	Membrane Systems	provided upon request	—	—
<b>PK</b>	Compressor Systems	10 000 m <sup>3</sup> /h (5886 cfm)	—	atmospheric to 12 barg (174 psig)



SIHI

#### DRY VACUUM PUMP

### SIHI<sup>dry</sup>

A completely dry running vertical twin-screw machine with no mechanical shaft seals. Designed for chemical, pharmaceutical, and industrial applications requiring uncontaminated vacuum, free from oil or service liquids.

- Lower life cycle cost made possible by dry operation, eliminating service liquids, lubrication and waste disposal costs
- Increased energy efficiency from intelligent drive system that performs ongoing rotor diagnostics while optimizing speed and pressure control
- Increased personnel safety enabled by low-noise, gearbox-free operation (all models), plus explosion-proof design for chemical and pharmaceutical models

#### SPECIFICATIONS

Suct. Cap. to: 1500 m<sup>3</sup>/h (900 cfm)  
 Ult. Press. to: <0.01 mbar (<0.007 torr)  
 Refer to literature PS-110-4 and PS-110-5 at [flowserve.com/library](http://flowserve.com/library).



SIHI

#### DRY VACUUM PUMP

### SIHI<sup>boost</sup>

Dual-stage vacuum systems that deliver deep vacuum with less power. Provides completely dry compression of gases from vacuum up to atmospheric conditions.

- Economical performance enabled by low power consumption and fast pump-down from atmosphere
- Lower maintenance costs and time from oil- and maintenance-free design with no gearbox, mechanical seals or other wearing parts
- Increased personnel safety and comfort due to low-noise operation

#### SPECIFICATIONS

Suct. Cap. to: 8000 m<sup>3</sup>/h (4800 cfm)  
 Ult. Press. to: <0.001 mbar (<0.0007 torr)



SIHI

#### LIQUID RING VACUUM PUMP

### LEM and LEL

Compact, single-stage liquid ring vacuum pumps featuring simple and robust construction. Typically used for handling and exhausting dry and humid gases as well as vapors and quantities of water carryover.

- Longer service life enabled by rotating parts with no metallic contact, oil/lubrication-free operation and efficient cavitation protection
- Ease of maintenance and reliable operation from integrated dirt and central drains, enabling reuse of service liquid
- Suitable for use in noise-sensitive environments due to very low noise levels and virtually vibration-free operation
- Environmental regulatory compliance assisted by non-polluting design with near-isothermal compression

#### SPECIFICATIONS

Suct. Cap. to: 470 m<sup>3</sup>/h (276 cfm)  
 Suct. Press: 33 to 1013 mbar (24.7 to 760 torr)

# VACUUM PUMPS & COMPRESSORS

## LIQUID RING VACUUM PUMP

### LEH



SIHI

Single-stage liquid ring vacuum pump with a bare shaft design. Often applied in distilling and degassing operations in the chemical, pharmaceutical and plastics industries.

- Easy maintenance and reliable operation with only one moving part and no internal lubrication required
- Increased personnel safety ensured by quiet, nearly vibration-free operation and liquid ring principle, ensuring the safest compression of hazardous and explosive vapors
- Broad application flexibility provided by ability to handle nearly all gases and vapors plus small quantities of entrained liquid

#### SPECIFICATIONS

Suct. Cap. to: 5150 m<sup>3</sup>/h (3030 cfm)  
Suct. Press: 33 to 1013 mbar  
(24.7 to 760 torr)

## LIQUID RING VACUUM PUMP

### LPH



SIHI

One- or two-stage vacuum pumps for the handling and exhausting of dry and humid gases. Entrained liquid can be handled during normal duty.

- Lower maintenance and more reliable operation thanks to standard O-ring sealing and oil-free design with no lubrication in working chamber
- Longer service life and minimized wear made possible by non-contacting parts, plus incorporated dirt and central drains
- Broad application versatility from wide range of available materials, including use as a compressor with little or no modification (depending on model)

#### SPECIFICATIONS

Suct. Cap. to: 12 000 m<sup>3</sup>/h (7063 cfm)  
Suct. Press: 33 to 1013 mbar  
(24.7 to 760 torr)

Refer to literature PS-110-1  
at [flowserve.com/library](http://flowserve.com/library).

## LIQUID RING COMPRESSOR

### KPH



SIHI

The KPH series offers efficient compression of condensable vapors and gases, using the liquid ring principle to ensure maximum safety when compressing hazardous mixtures. Single and multistage designs available.

- Increased personnel safety from low-temperature rise of liquid ring principle, ensuring the safest compression of thermally sensitive, hazardous or explosive process gases
- Reduced electrical installation and operating costs provided by low starting torque
- Longer service life and reduced maintenance owing to non-contacting rotor design, which has only one moving part and does not require internal lubrication
- Increased flexibility in process applications made possible by ability to function at inlet pressures lower or higher than atmospheric pressure

#### SPECIFICATIONS

Suct. Cap. to: 11 000 m<sup>3</sup>/h (6475 cfm)  
Comp. Press: atmospheric to  
12 barg (174 psig)

Refer to literature PS-110-2  
at [flowserve.com/library](http://flowserve.com/library).



VACUUM SYSTEM

PL



SIHI

These tailor-made vacuum systems are individually designed for trouble-free operation in almost any application, including heavy-duty and critical applications.

- Plant and personnel safety in explosive atmospheres ensured by compliance with ATEX equipment directives and other explosion protection directives
- Broad application flexibility enabled by different pump sizes and design of multistage systems, including ejectors and roots blowers
- Design in accordance with European or American standards as well as customer specifications
- Lower maintenance costs and time owing to extremely robust, corrosion-resistant design

SPECIFICATIONS

Suct. Cap. to: 10 000 m<sup>3</sup>/h (5886 cfm)

Suct. Press: 5 mbar (4 torr) to atmospheric

Refer to literature PS-110-3 at [flowserve.com/library](http://flowserve.com/library).

MEMBRANE SYSTEM

PM



SIHI

SIHI membrane technology efficiently separates process media from inert gas for recycling or recovery. The result is a very simple and highly effective means of pure substance recovery and emission control.

- Environmental regulatory compliance assured by membrane that allows recovery of desired element while clean inert gas passes freely to atmosphere
- Very long service life with minimal maintenance via simple, compact design requiring no regeneration
- Broad application versatility enabled by ability to process most solvents, monomers, esters, aldehydes, nitriles, aromatics or aqua
- Recovery rates up to 99%

SPECIFICATIONS

Suct. Cap. to: provided on request

Refer to literature PS-110-3 and PS-110-6 at [flowserve.com/library](http://flowserve.com/library).

COMPRESSOR SYSTEM

PK



SIHI

Dependable compression makes this liquid-ring technology invaluable, even for the fiercest or thermally unstable processes.

- Plant and personnel safety in explosive atmospheres ensured by compliance with ATEX equipment directives
- Lower maintenance costs and time enabled by extremely robust, corrosion-resistant design
- Economical performance and longer service life from superior liquid, vapor and solids handling, plus effective heat exchanger

SPECIFICATIONS

Suct. Cap. to: 10 000 m<sup>3</sup>/h (5886 cfm)  
Suct. Press: atmospheric to 12 barg (174 psig)

Refer to literature PS-110-3 at [flowserve.com/library](http://flowserve.com/library).



*N-Seal*

## SPECIALTY PRODUCTS

When customers need absolute reliability in specialty applications, they draw on our proven engineering and development capabilities. Our reputation for reliability is exemplified by a nuclear heritage that features ASME Section III, Class 1 products performing reliably in primary coolant and other essential applications globally. Energy recovery devices save desalination plants millions of dollars in operating costs. And, our proprietary systems control critical reactions and processes in refineries around the world.

### Specialty Products – Quick Reference\*

Product	Sub-Type	Flows to	Heads to	Pressures to	Temperatures
<b>N-Seal™</b>	Nuclear Primary Pump Seals	—	—	150 bar (2175 psi)	—
<b>DFSS and DVSS</b>	Nuclear	24 500 m <sup>3</sup> /h (108 000 gpm)	250 m (820 ft)	170 bar (2500 psi)	to 300°C (580°F)
<b>WDF</b>	Nuclear	900 m <sup>3</sup> /h (4000 gpm)	245 m (800 ft)	41 bar (600 psi)	to 205°C (400°F)
<b>CN</b>	Nuclear	5100 m <sup>3</sup> /h (22 500 gpm)	750 m (2460 ft)	120 bar (1740 psi)	to 206°C (402°F)
<b>CA</b>	Nuclear	5225 m <sup>3</sup> /h (23 000 gpm)	4300 m (14 000 ft)	517 bar (7500 psi)	to 250°C (480°F)
<b>RLIJ</b>	Nuclear	109 m <sup>3</sup> /h (480 gpm)	1270 m (4160 ft)	151 bar (2200 psi)	to 250°C (480°F)

\* Additional products shown on next page

## Specialty Products – Quick Reference, cont'd.

Product	Sub-Type	Flows to	Heads to	Pressures to	Temperatures
<b>CAM</b>	Nuclear	60 m <sup>3</sup> /h (265 gpm)	1920 m (6300 ft)	200 bar (3000 psi)	to 120°C (250°F)
<b>EG</b>	Nuclear	4000 m <sup>3</sup> /h (17 610 gpm)	60 m (200 ft)	14 bar (200 psi)	to 80°C (180°F)
<b>MEV</b>	Nuclear	5400 m <sup>3</sup> /h (23 760 gpm)	50 m (160 ft)	14 bar (200 psi)	to 80°C (180°F)
<b>LBSZ</b>	Nuclear	400 m <sup>3</sup> /h (235 cfm)	—	—	to 100°C (212°F)
<b>KBSZ</b>	Nuclear	250 m <sup>3</sup> /h (147 cfm)	—	—	to 100°C (212°F)
<b>KSCZ</b>	Nuclear	650 m <sup>3</sup> /h (2860 gpm)	350 m (1250 ft)	80 bar (1160 psi)	to 180°C (356°F)
<b>Hydraulic Decoking Systems</b>	Hydraulic Decoking Systems	—	—	—	—
<b>ERT</b>	Energy Recovery Device	1200 m <sup>3</sup> /h (5280 gpm)	—	80 bar (1160 psi)	—
<b>DWEER™</b>	Energy Recovery Device	350 m <sup>3</sup> /h (1.4 mgd) per unit	—	82 bar (1200 psi)	—
<b>CVP</b>	Concrete Volute	200 000 m <sup>3</sup> /h (880 000 gpm)	60 m (197 ft); custom designs to 90 m (295 ft)	—	—
<b>AFH9500</b>	Polyolefin Reactor	18 180 m <sup>3</sup> /h (80 000 gpm)	40 m (131 ft)	100 bar (1450 psi)	-45°C to 349°C (-49°F to 660°F)

NUCLEAR PRIMARY PUMP SEALS

## N-Seal

The N-Seal primary pump seal is the nuclear industry's most advanced mechanical seal technology. Developed for all OEM reactor coolant, heat transport and recirculation pumps, it is found in NPPs around the world.



Flowserve

- Increased safety assured by a two- to four-stage redundant design wherein each stage is capable of handling 100% of the system pressure
- Low conversion costs, since piping and instrumentation modifications are seldom required and Design Change Package (DCP) costs are minimized
- Dramatically improved reliability and running periods with hydrodynamic seal faces with variable face topography
- Improved safety with available patented Abeyance Seal, a passive backup seal for loss of coolant scenarios

SPECIFICATIONS

Press. to: 150 bar (2175 psi)  
Refer to literature PS-80-2 and FPD-2 at [flowserve.com/library](http://flowserve.com/library).

NUCLEAR

## DFSS and DVSS

These ASME Section III, Class 1, radially split, single-stage pumps are designed for primary coolant, reactor recirculation and primary heat transport service in BWR, PWR and PHWR plants.

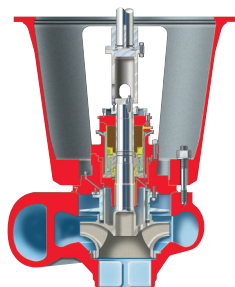

Byron Jackson

- Highly reliable one-piece pump casing features a double-volute design for BWR and PHWR applications and a diffuser with a torus-type casing for PWR service
- Increased uptime with upgraded rotating element that uses a one-piece welded shaft-impeller-journal assembly
- Improved safety with hydrostatic-pressurized radial bearing that operates submerged in radioactive system water with no external source of cooling water
- Extensive licensed and certified aftermarket support network, including hot shop and code Class 1, 2 and 3 support

SPECIFICATIONS

Flows to: 24 500 m<sup>3</sup>/h (108 000 gpm)  
Heads to: 250 m (820 ft)  
Press. to: 170 bar (2500 psi)  
Temp. to: 300°C (580°F)  
Refer to literature FPD-2 at [flowserve.com/library](http://flowserve.com/library).

NUCLEAR

## WDF

Safe and reliable single-stage, diffuser-style pump for residual heat removal applications in nuclear power stations. Built to ASME Section III, it meets the requirements of advanced pressurized water reactors.

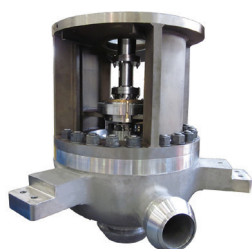

IDP

- Ease of maintenance resulting from a removable four-piece spacer coupling that allows easy access to the bearing and mechanical seal
- Extended seal and bearing life ensured by a heavy-duty motor support head that dampens vibration
- Reliability due to a cartridge-type, single mechanical seal with integral disaster bushing plus tungsten carbide and carbon seal faces
- Reduced maintenance costs through a robust rotor with a large shaft diameter and tapered fit at the coupling hub to reduce deflection and vibration

SPECIFICATIONS

Flows to: 900 m<sup>3</sup>/h (4000 gpm)  
Heads to: 245 m (800 ft)  
Press. to: 41 bar (600 psi)  
Temp. to: 205°C (400°F)  
Refer to literature PS-80-5 at [flowserve.com/library](http://flowserve.com/library).

# SPECIALTY PRODUCTS

## Increase Production With the IOT

Flowserve is helping clients achieve step-change increases in production by applying industrial internet principles, technologies and related reliability services to pumps and rotating equipment. By developing scalable systems that capture and make sense of equipment data, Flowserve can offer a practical and economical solution for predictive versus reactive maintenance.



IDP

### NUCLEAR CN

Radially split, single-stage, double-suction, high-speed pump that features a rugged diffuser-style barrel design engineered to meet ASME Section IV Division 1 requirements for commercial nuclear power plants.

- Ease of maintenance facilitated by replaceable casing wear rings that enable running clearances to be renewed easily
- Lower operating costs provided by precision-cast chrome steel impellers, which ensure hydraulic efficiency and performance repeatability
- Reduced downtime facilitated by 416 stainless steel shaft, which is ground in steps to minimize stresses and stress relieved in the vertical position to prevent warping

#### SPECIFICATIONS

Flows to: 5100 m<sup>3</sup>/h (22 500 gpm)  
Heads to: 750 m (2460 ft)  
Press. to: 120 bar (1740 psi)  
Temp. to: 206°C (402°F)

Refer to literature PS-80-4 at [flowserve.com/library](http://flowserve.com/library).



IDP

### NUCLEAR CA

Radially split, between-bearing, multistage barrel pump designed to comply with ASME Section III Class 2 and 3 for nuclear safety injection and emergency feedwater service.

- Increased MTBR with precision-cast diffusers, which minimize bearing spans
- Increased reliability provided by serrated impeller running fits that reduce effects of rotor contact during system upsets or turning gear operation
- Ease of maintenance provided by casing rings that enable running clearances to be renewed easily
- Installation flexibility owing to suction and discharge connections that can be on the top or bottom of the barrel with flanged or weld-end designs

#### SPECIFICATIONS

Flows to: 5225 m<sup>3</sup>/h (23 000 gpm)  
Heads to: 4300 m (14 000 ft)  
Press. to: 517 bar (7500 psi)  
Temp. to: 250°C (480°F)

Refer to literature PS-30-13 at [flowserve.com/library](http://flowserve.com/library).

## NUCLEAR

## RLIJ

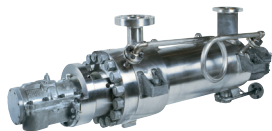

Pacific

Reliable nuclear pump designed to handle low-flow and high-speed operations, frequent starts and stops, and operating upsets for prolonged pump life.

- Increased uptime provided by metal-to-metal discharge head and bearing housing, which provide improved rigidity for enhanced rotor and stator internal alignment
- Longer service life via high-strength CA625 shafting, which offers higher endurance limits, increased ductility and improved corrosion resistance
- Lower operating costs with optimized impellers and diffusers, which provide hydraulic efficiency and reduce power consumption
- Ease of installation and maintenance made possible by optional PTO cartridge seal, an integral sleeve and pumping ring for enhanced self-aligning capabilities

## SPECIFICATIONS

Flows to: 109 m<sup>3</sup>/h (480 gpm)  
 Heads to: 1270 m (4160 ft)  
 Press. to: 51 bar (2200 psi)  
 Temp: to 250°C (480°F)

Refer to literature PS-80-1 at [flowserve.com/library](http://flowserve.com/library).

## NUCLEAR

## CAM



IDP

Double-casing, multistage diffuser pump for PWR chemical and volume control charging or BWR control rod drive applications. Can be supplied in compliance with ASME Section III, Class 3 or RCC-M where required.

- Improved low-flow stability and reliability across a wide range of flows via modular impeller design that limits surging and pulsations
- Lower operating costs from ball-ball bearing arrangement that doesn't require external, force-fed lube oiling system or cooling
- Reduced maintenance requirements enabled by dry disk spacer coupling that facilitates component servicing

## SPECIFICATIONS

Flows to: 60 m<sup>3</sup>/h (265 gpm)  
 Heads to: 1920 m (6300 ft)  
 Press. to: 200 bar (3000 psi)  
 Temp: to 120°C (250°F)

Refer to literature PS-80-6 at [flowserve.com/library](http://flowserve.com/library).

## NUCLEAR

## EG

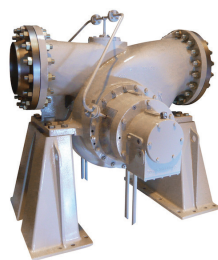

IDP

Reliable single-stage, double-suction, radially split case, heavy-duty process pump specifically designed for component cooling water service in nuclear power plants. Conforms to ASME Section III, Class 3 and RCC-M.

- Equal thermal expansion enabled by centerline mounted design
- Exceeds piping requirement by twofold via suction and discharge flange connections in the top portion of the pump case
- Reduced NPSHR over the operating range of the pump through double-suction impeller design
- Lower maintenance costs with standard cartridge seals and a radially split casing, which allows access without having to disconnect suction and a discharge piping

## SPECIFICATIONS

Flows to: 4000 m<sup>3</sup>/h (17 610 gpm)  
 Heads to: 60 m (200 ft)  
 Press. to: 14 bar (200 psi)  
 Temp: to 80°C (180°F)

Refer to literature FPD-2 at [flowserve.com/library](http://flowserve.com/library).

# SPECIALTY PRODUCTS

## NUCLEAR

### MEV



Flowserve

Bottom-suction, side-discharge vertical pump equipped with a mechanical seal and grease-lubricated bearings for use in water services in nuclear power plants. Conforms to ASME Section III, Class 3 and RCC-M..

- Extended service life from roller guide bearing above the seal design that minimizes motor vibration to the seal
- Functional qualifications per bottom-suction and side-discharge connections designed to meet specified piping requirements
- Lower maintenance costs via spacer coupling that facilitates bearing and seal replacement without removal of motor

#### SPECIFICATIONS

Flows to: 5400 m<sup>3</sup>/h (23 760 gpm)  
Heads to: 50 m (160 ft)  
Press. to: 14 bar (200 psi)  
Temp: to 80°C (180°F)

Refer to literature FPD-2  
at [flowserve.com/library](http://flowserve.com/library).

## NUCLEAR

### LBSZ

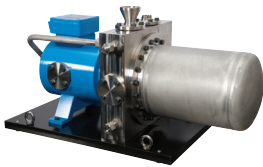

SIHI

Sealless liquid ring vacuum systems with canned motors engineered for degassing of water within the primary loop of the reactor.

- Environmental and regulatory compliance and personnel safety ensured by the leak-free canned design guaranteed to 10<sup>-6</sup> mbar/l/sec
- Extended uptime via extremely robust suction and discharge casing constructed from forged steel and designed to meet highest seismic requirements
- Reliable performance facilitated by long MTBF, which includes no oscillating parts, non-contacting parts and no axial thrust

#### SPECIFICATIONS

Flows to: 400 m<sup>3</sup>/h (235 cfm)  
Suct. Press. to: 125 mbar (94 torr)  
to atmosphere  
Des. Press. to: 12 bar (174 psi)  
Temp: to 100°C (212°F)

## NUCLEAR

### KBSZ

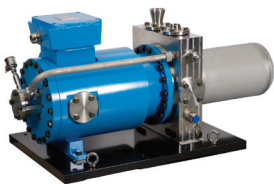

SIHI

Sealless liquid ring compressor systems with canned motors designed to extract waste radioactive gas from a nuclear island and deliver it to a treatment system.

- Environmental and regulatory compliance and personnel safety ensured by the leak-free canned design guaranteed to 10<sup>-6</sup> mbar/l/sec
- Extended uptime via extremely robust suction and discharge casing constructed from forged steel and designed to meet highest seismic requirements
- Reliable performance facilitated by long MTBF, which includes no oscillating parts, non-contacting parts and no axial thrust

#### SPECIFICATIONS

Flows to: 250 m<sup>3</sup>/h (147 cfm)  
Comp. Press. to: 8 bar (116 psi)  
Des. Press. to: 30 bar (435 psi)  
Temp: to 100°C (212°F)



NUCLEAR

KSCZ

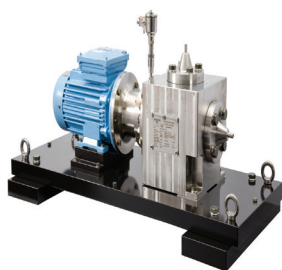

SIHI

Sealless liquid systems with side channel or centrifugal hydraulics in canned motor or magnetic coupling design used for different applications in nuclear power plants.

- Environmental and regulatory compliance and personnel safety ensured by the leak-free canned design guaranteed to 10<sup>-6</sup> mbar/l/sec
- Extended uptime via extremely robust suction and discharge casing constructed from forged steel and designed to meet highest seismic requirements
- Reliable performance facilitated by long MTBF, which includes no oscillating parts, non-contacting parts and no axial thrust

SPECIFICATIONS

Flows to: 650 m<sup>3</sup>/h (2860 gpm)  
 Heads to: 350 m (1250 ft)  
 Press. to: 80 bar (1160 psi)  
 Temp: to 180°C (356°F)

Profit From Our Expertise

Flowserve pump training programs help plant operators, reliability specialists, engineers and maintenance personnel deepen their understanding of pumping systems. Attendees learn how to maximize plant availability, improve pump reliability and increase mean time between repair, all of which positively impact the bottom line. Courses are available at our global network of Learning Resource Centers, online and even on-site. **Get details at [www.pumptraining.com](http://www.pumptraining.com).**



HYDRAULIC DECOKING SYSTEMS

Hydraulic Decoking Systems

Installed in more than 95% of the world's DCUs, Flowserve hydraulic decoking systems are the world's most advanced. They provide refiners with maximized unit output, increased unit reliability and unparalleled personnel safety.



Flowserve

- Increased unit capacity and efficiency with automated hydraulic decoking systems that include virtually all equipment needed to operate and control the process
- Significantly improved operator safety with remote and automated system options, including AutoShift™ combination cutting tool, cutting tool enclosure, fully integrated instrumentation feedback and coke drum monitoring
- Increased unit uptime with online assurance programs that enable experts to monitor, diagnose and communicate operating solutions in real time
- Access to extensive aftermarket support

MAJOR SYSTEMS

- ISO 13709/API 610 (BB5) jet pump train
- Coke cutting system
- Automation, controls and instrumentation

Refer to literature PS-90-6 and PS-90-22 at [flowserve.com/library](http://flowserve.com/library).

## SPECIALTY PRODUCTS

### ENERGY RECOVERY DEVICE

## ERT

Highly efficient and reliable, Calder energy recovery turbines (ERT) are installed in nearly 1000 seawater and brackish water reverse osmosis plants worldwide, with a total installed capacity in excess of 350 MW.

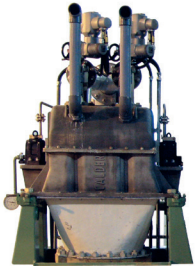

Calder

- Highly efficient energy recovery over a wide range of operating pressures due to flat efficiency curve
- Repeatable performance due to adjustable nozzle assembly that allows the original operating conditions to be re-established quickly
- Reduced downtime enabled by horizontal split-case design, which provides easy access for rotor inspection without disturbing alignment
- Installation ease with standard ANSI discharge; DIN flange discharge available
- Corrosion-resistant, super duplex stainless steel or FRP construction for long life

#### SPECIFICATIONS

Brine Flows to: 1200 m<sup>3</sup>/h (5280 gpm)  
Efficiency: to 90%  
Pressure to: 80 bar (1160 psi)  
Refer to literature FPD-18  
at [flowserve.com/library](http://flowserve.com/library).

### ENERGY RECOVERY DEVICE

## DWEER

The Dual Work Exchanger Energy Recovery (DWEER) is the most efficient energy recovery technology available today. No other technology achieves higher efficiency or lower SWRO plant operating costs.

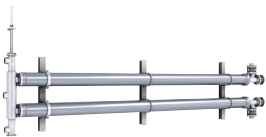

Calder

- Unmatched operational flexibility resulting from a robust isobaric design that tolerates fluctuations in flow and pressure with no loss of performance
- Precise control of the energy transfer mechanism due to the LinX<sup>®</sup> valve
- Reduced construction costs, as the DWEER uses only a basic header design, plus its footprint and associated piping runs are easily optimized for the site
- Lower operating costs, since special flushing procedures, strainers or filtration systems are not needed
- Quiet operation so noise hoods or enclosures are not needed

#### SPECIFICATIONS

Brine Flows to: 350 m<sup>3</sup>/h (1.4 MGD)  
per unit  
Efficiency: to 98%  
Pressures: 82 bar (1200 psi)  
Refer to literature FPD-18  
at [flowserve.com/library](http://flowserve.com/library).

### CONCRETE VOLUTE

## CVP (BSV and BCV)

Made of prefabricated concrete segments for the volute housing and intake suction bell, CVP pumps are used in a variety of high-capacity water applications in water resources, power generation and desalination.

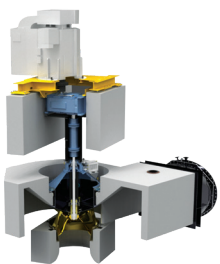

Flowserve

- Reduced total lifecycle costs with concrete construction, which substantially reduces vibration and maintenance
- Significantly lower construction time and costs due to compact, prefabricated elements that reduce excavation work as compared to wet-pit pumps
- Easy inspection access through manholes; no dismantling necessary
- Efficient vortex-free operation with no dead water areas or sand deposits
- Corrosion-resistant concrete construction with the impeller, wear ring and cover being the only metallic wetted components

#### SPECIFICATIONS

Flows to: 200 000 m<sup>3</sup>/h (880 000 gpm)  
Heads to: 60 m (197 ft); custom designs  
to 90 m (295 ft)  
Refer to literature FPD-18  
at [flowserve.com/library](http://flowserve.com/library).

## POLYOLEFIN REACTOR

## AFH9500

Developed specifically for loop reactor circulation, the AFH9500 high-pressure axial flow pump delivers increased plant productivity, earning it a well-earned reputation as the industry's preferred pump for polyolefin production.

- Superior process control provided by propellers engineered with steep pump head curves to ensure performance requirements are met
- Unspared pump reliability ensured by conservatively engineered bearing system plus high-pressure elbow casing designed, fabricated and tested per ASME Boiler and Pressure Vessel Code, Section VIII, Division 1 and applicable international standards
- Added safety and uptime with standard triple-seal arrangement and API Plan 32/53C/52 seal support system

## SPECIFICATIONS

Flows to: 18 180 m<sup>3</sup>/h (80 000 gpm)

Heads to: 40 m (131 ft)

Press. to: 100 bar (1450 psi)

Temp: -45°C to 349°C

(-49°F to 660°F)

Refer to literature PS-90-23

at [flowserve.com/library](http://flowserve.com/library).



*Lawrence Pumps*



## REFERENCE SOURCES

### AFFINITY™ PUMP SELECTION TOOL

Affinity is the latest state-of-the-art pump selection program from Flowserve. This user-friendly and intuitive web-based tool delivers immediate, real-time access to the latest, most accurate data on more than 80 Flowserve pump models.

Customers have access to the same pump selection tool that is used by Flowserve application engineers. Use it to size a pump for a new application or obtain performance information for an existing installed unit. Users can save selections for future reference and generate technical documents specific to their hydraulic selection. They can also request for a Flowserve representative to review their selections and provide a formal quote.

Access it at [www.flowserve.com/affinity](http://www.flowserve.com/affinity).



### CAMERON HYDRAULIC DATA

The Cameron Hydraulic Data book is a handy reference on the subject of hydraulics and steam. Now in its 19<sup>th</sup> edition, it is an indispensable aid to engineers involved with the specification, selection and application of process equipment.

This comprehensive reference tool includes:

- Hydraulic principles and formulae
- Friction data
- Properties of common liquids
- Steam and electrical data
- Weights, dimensions, and ratings of pipe flanges and fittings
- Metric conversions

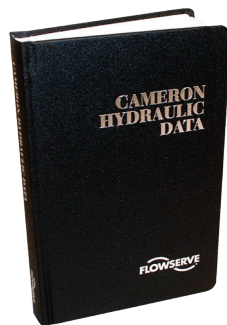

To order the Cameron Hydraulic Data book, visit:  
[www.pumptechnicalbooks.com](http://www.pumptechnicalbooks.com).

### PUMP ENGINEERING MANUAL

This publication is devoted to explaining centrifugal pump principles. It covers the basics, from application analysis and affinity laws through hydraulics and mechanical phenomena to troubleshooting.

To order the Pump Engineering Manual, visit:  
[www.pumptechnicalbooks.com](http://www.pumptechnicalbooks.com).



# INDEX

## A

ADH .....	72
AEH.....	71
AFH9000.....	36
AFH9500.....	91
AFV .....	56
AKH .....	71
AKL and AKV .....	74
AOH .....	72
APKD .....	58
ASH .....	72

## B

Barge VTP.....	56
BP .....	50
Byron Jackson SUBM - H2O.....	59
Byron Jackson SUBM - OIL.....	59

## C

CA.....	86
CAM.....	87
CBE and CBM.....	25
CBT.....	26
CEB .....	73
CEH .....	71
CHTA .....	50
CN .....	86
CPXV.....	62
CSB .....	49
CSX.....	47
CT6.....	66
CVP (BSV and BCV) .....	90

## D

D800 .....	26
DBS .....	28
DFSS and DVSS.....	85
DMX.....	44
DRV.....	74
DS.....	27
DVSH .....	42
DVSR .....	45
DWEER .....	90

## E

EC.....	44
ECPJ.....	63
EG.....	87
ERPNI .....	34
ERT .....	90
ESP3.....	62

## F

F-Line.....	29
FRBH .....	30

## G

GA.....	66
Gearex .....	67
GR .....	66
Guardian .....	24



## H

HDB and HSB .....	50
HDO and HSO.....	51
HDX .....	44
HED and HED-DS .....	45
HEGA.....	46
HPX.....	33
HPX6000 and HPXM6000 .....	36
HWMA .....	34
HWX.....	35
Hydraulic Decoking Systems .....	89

## K

KBSZ .....	88
KPH .....	80
KSCZ .....	89

## L

LBSZ.....	88
LC .....	33
LEH.....	80
LEM and LEL.....	79
LNN.....	42
LPH.....	80
LPN.....	43
LR .....	42

## M

M.....	32
Mark 3 ANSI.....	24
Mark 3 ISO .....	24
ME .....	27
MEN and MENBLOC.....	26
MEV .....	88
MF and MFV.....	31
MJ and MJC.....	60
MN and MNV .....	31
Molten Salt VTP.....	57
MP1 .....	67
MPT .....	30
MSL, MSM, MSC and MSH.....	48
MSP .....	35
MSX .....	31
MVE .....	30
MVX .....	61

## N

NM .....	48
N-Seal.....	85

## P

PHL.....	33
PK.....	81
PL .....	81
PM .....	81
PolyChem VGRP .....	62
PVML .....	35
PVXM .....	34

# INDEX

## Q

QL and QLQ.....	55
QLC and QLQC.....	57

## R

R.....	32
RJ and RJC.....	60
RLIJ.....	87

## S

SC.....	73
SIHI <sup>boost</sup> .....	79
SIHI <sup>dry</sup> .....	79
SMP.....	29
SMX.....	73

## T

TB-MAG.....	25
Terra-Titan.....	60
Titan-Slurry.....	32
TKH.....	46
TSP.....	67

## U

UEA.....	46
U-MAG.....	25
UZDL.....	43

## V

VCT.....	56
VPC.....	58
VPL1700.....	63
VPL3300.....	61
VPL3600.....	61
VTP.....	55

## W

WCC.....	51
WD and WDX.....	47
WDF.....	85
WIK and WIKO.....	51
WTB.....	45
WUC.....	58
WUJ.....	55
WX.....	47
WXB and WXB-B.....	49
WXH and WXM.....	48

## Z

ZEN, ZDN, ZHN and ZDI.....	28
ZLN, ZLK and ZLI.....	27
ZTN, ZTK and ZTI.....	28



Flowserve Corporation  
5215 North O'Connor Blvd.  
Suite 700  
Irving, Texas 75039-5421 USA  
Telephone: +1 937 890 5839

**FLS-1001b (EN/A4)** May 2023

Flowserve Corporation has established industry leadership in the design and manufacture of its products. When properly selected, this Flowserve product is designed to perform its intended function safely during its useful life. However, the purchaser or user of Flowserve products should be aware that Flowserve products might be used in numerous applications under a wide variety of industrial service conditions. Although Flowserve can provide general guidelines, it cannot provide specific data and warnings for all possible applications. The purchaser/user must therefore assume the ultimate responsibility for the proper sizing and selection, installation, operation, and maintenance of Flowserve products. The purchaser/user should read and understand the Installation Instructions included with the product, and train its employees and contractors in the safe use of Flowserve products in connection with the specific application.

While the information and specifications contained in this literature are believed to be accurate, they are supplied for informative purposes only and should not be considered certified or as a guarantee of satisfactory results by reliance thereon. Nothing contained herein is to be construed as a warranty or guarantee, express or implied, regarding any matter with respect to this product. Because Flowserve is continually improving and upgrading its product design, the specifications, dimensions and information contained herein are subject to change without notice. Should any question arise concerning these provisions, the purchaser/user should contact Flowserve Corporation at any one of its worldwide operations or offices.

©2023 Flowserve Corporation. All rights reserved. This document contains registered and unregistered trademarks of Flowserve Corporation. Other company, product, or service names may be trademarks or service marks of their respective companies.